

Modeling dissolved organic matter mobilization and immobilization in the root zone

- Effect of soil treatment on denitrification and N leaching

Birgitte Gjettermann

**The Royal Veterinary and Agricultural University
Department of Agricultural Science**

June 2005

Preface

This report describes results and considerations for the work package WP5 for the research program *Regional Groundwater Protection by Optimized Organic Farming Systems* financed by Danish Research Centre for Organic Farming.

This report summarizes the technical description of a code/model concept simulating mobilization and immobilization of dissolved organic matter (DOM) in the Daisy model. This report also describes the simulated effects of duration of grass-clover, time of soil ploughing, and catch crops on denitrification and N leaching.

This model concept of DOM mobilisation and immobilisation was developed in corporation with an industrial Ph.D.-project *Modelling Phosphorus Dynamics in Soil – Decomposition and Sorption*, at DHI Water & Environment in association with The Royal Veterinary and Agricultural University (KVL). The Danish Academy of Technical Science and DHI Water & Environment financed the industrial Ph.D.-project.

Contents

1	Modeling DOM mobilization and immobilization in the root zone.....	4
1.1	Biologically DOM turnover	4
1.2	Sorption/desorption of DOM	6
1.2.1	DOM sorption/desorption at equilibrium	7
1.2.2	Null-point concentration of DOC	9
1.2.3	The kinetic approach of DOM sorption	10
1.3	Parameterization of DOM module	12
1.4	Calibration of DOM module	15
1.4.1	Hydraulic and textural properties	15
1.4.2	Soil treatments	16
1.5	Results of DOM calibration at the Burrehøjvej fields	18
1.5.1	Summary of DOM calibration	22
2	Effect of soil treatment on denitrification and nutrient leaching.....	23
2.1	Root zone parameterization	23
2.1.1	Hydraulic and textural properties	23
2.1.2	Soil treatments	24
2.1.3	Output	25
2.2	Effects of soil treatments on soil denitrification and N leaching	26
2.2.1	Duration of grass-clover cover.....	26
2.2.2	Time of soil ploughing	29
2.2.3	Effect of catch crops	32
2.3	Conclusion.....	35
2.3.1	Denitrification.....	35
2.3.2	N-leaching	35
3	Reference List	36
	Appendix 1. Daisy setup for DOM calibration	39
	Definitions of the horizons and the soil column of Burrehøjvej field	39
	Definition of crops, tillage and manure	41
	Deposition of manure by grazing cattle	41
	Cutting grass-clover by grazing cattle	42
	Management for 1-year ploughed	42
	Management for 8-year ploughed	44
	Management for 9-year grass-clover	46
	Output	48
	Appendix 2. Daisy setup for denitrification and N-leaching analysis ...	50
	Definition of the Jyndevad soil.....	50
	Managements for the warm-up phase and the 2, 5 and 9 year of grass-clover.....	52

1 Modeling DOM mobilization and immobilization in the root zone

Dissolved organic matter (DOM) is supposed to represent the most active and mobile form of organic matter in soil (Zech, 1997; Zsolnay, 1996). DOM mobility is a major factor affecting the export of nutrients from soils to surface waters. E.g. nitrogen (N) and phosphorus (P) in DOM can make up a significant fraction of total dissolved concentrations of N and P in soil pore water. Thus, Qualls et al. (1991) estimated that > 90 % and > 66 %, respectively, of total dissolved N and P leaching from a deciduous forest soil were in the form of dissolved organic N (DON) and dissolved organic P (DOP), respectively. Additionally, this mobile fraction may be of importance for the microbial biomass and activity in deeper soil layers and thereby increasing the potential for denitrification (Vinther et al., 2005a)

DOM is usually quantified in term of its carbon content, which is referred to as dissolved organic carbon (DOC) and generally, DOC comprises 50 % of DOM (Tipping et al., 1999). However, DON also plays an important role in nutrient cycling as DON represent labile, readily mineralizable pools that will be important to the availability of these nutrients particularly in unfertilized soils and in the subsoil.

Weather-driven simulation modeling has become an important component of studies of soil nutrients, both for crop growth and for losses by leaching to the environment as pollutants. In order to model DOM leaching from agricultural land, this was included in the Daisy model. Daisy¹ is a public shareware developed at the Royal Veterinary and Agricultural University (KVL), which simulates N and C dynamics in the soil-plant-atmosphere system and consists of several sub-models for soil water and solute movement, soil temperature, soil organic matter, soil mineral N, crop growth, and system management (Hansen et al., 1990; Abrahamsen and Hansen, 2000).

This paragraph describes the model concept of simulating DOM mobilization and immobilization in the root zone. DOM is defined as dissolved organic substances passing through a 0.45 µm filter. In Daisy the dissolved substances are quantified with respect to C and N, which are referred as DOC, and DON, respectively.

1.1 *Biologically DOM turnover*

Microbes selectively degrade the less recalcitrant compounds and thus gradually increase the average recalcitrance of the non-respired organic matter (Sollins et al., 1996). In order to divide the dead native soil organic matter into recalcitrant and less recalcitrant fractions, it is fractionated into three pools with different turnover rates, SOM1, SOM2 and SOM3, respectively. In some organic soil as peat soils, a large humified pool may be almost inert. The SOM3 pool represents a deactivated pool of humified organic matter. SOM1 is considered as the chemically stabilized organic matter, which is decomposed at a relatively slow rate. SOM2 is physically stabilized organic matter decomposing relatively fast, approximately three times faster than SOM1. SOM2 is considered as the least recalcitrant and stabilized fraction of SOM and it is the most bioavailable fraction for microbes.

Added organic matter (AOM) is defined as input of new organic substances to the soil system. AOM could be organic fertilizer as farmyard manure or slurry. Additionally, green crops, roots or plant residues left on the field after harvest, are input of new organic material and subject for degradation in the organic matter cycle. As for SOM, input of new organic substances is

¹ For further information of the public model Daisy, see <http://www.dina.kvl.dk/~daisy/>.

fractionated into two fractions, AOM1 and AOM2, which consist of relatively slowly and easily degradable organic matter, respectively. However, some fraction of partly decomposed organic matter as farmyard manure or slurry can also be allocated to the SOM2 fraction as it is already partly degraded by microbes.

Microorganisms in soil may be classified into two groups with different strategies. The primary stage of decomposition of readily decomposable substrates is performed by rapidly responding life forms. The subsequent stage is dominated by slower growing, highly specialized life forms (Insam, 1996). In order to have a stable as well as a dynamic microbial biomass; the soil microbial organic matter fraction is subdivided into SMB1 and SMB2. The SMB1 fraction is considered to be the stable fraction while SMB2 is the dynamic fraction.

In summary, organic matter is allocated to three defined fractions in Daisy: Added organic matter (AOM), dead native soil organic matter (SOM), and soil microbial biomass (SMB) which is further divided into more and less dynamic pools. A fourth more arbitrary fraction is defined in the following section, dissolved organic matter (DOM).

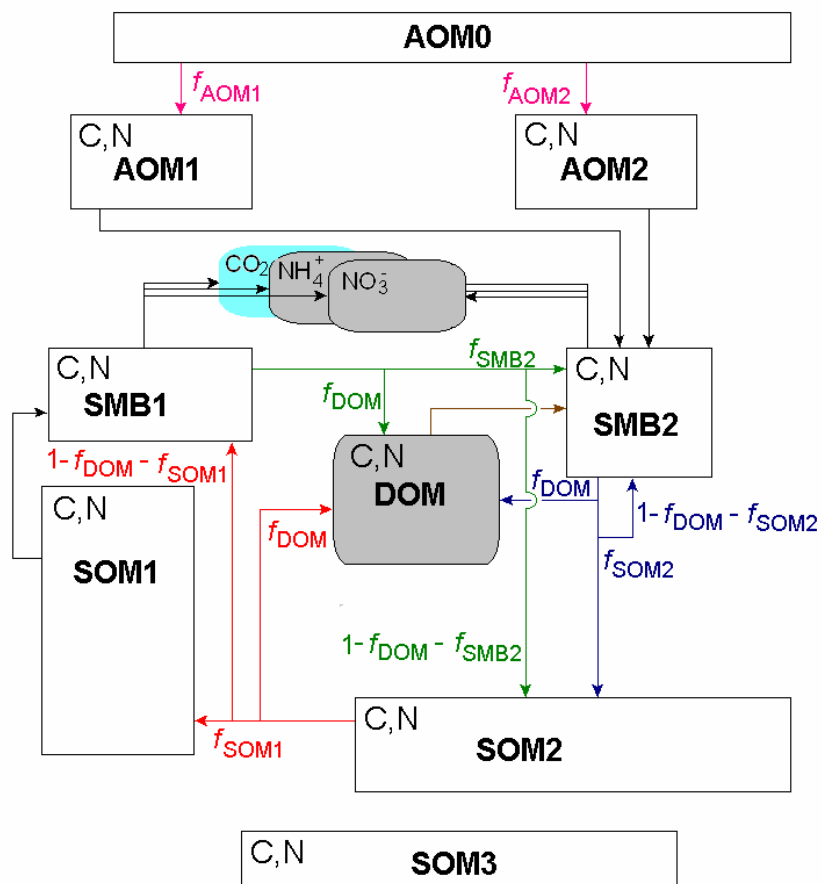

Figure 1. Interrelationship between the soil organic fractions in the Daisy model showing the partitioning coefficients, f_x , to the different pools X. AOM1 and AOM2 correspond to the slowly and easily degradable added organic matter, respectively. SOM1 and SOM2 correspond to the slowly and easily degradable soil organic matter, respectively. SOM3 is inert soil organic matter. The soil microbial biomass is subdivided into SMB1 and SMB2, which are considered to be the stable and the dynamic fractions, respectively.

Soil solutions contain varying amounts of DOM, which originate from plant litter, soil humus, and microbial biomass or from root exudates (Kalbitz et al., 2000). As DOM moves deeper into the soil, its biological availability decreases, reflecting either transport of residual, recalcitrant components of DOM, or a physical desorption / dissolution flux of C from SOM to DOM (Qualls and Haines, 1992). DOM is produced principally by microbial activity, root exudation, and leaching from litter and humus in the soil. However, the quantitative contribution made by each of these sources is controversial. In Daisy it is considered, that DOM is produced from rather old organic matter fractions. It is assumed that easily degradable new dissolved organic components from root exude and organic fertiliser is rapidly consumed by microbes and can not be distinguished from the AOM pools. This is supported by findings of ^{14}C studies by Tegen and Dorr (1996), Trumbore et al. (1992) and Hagedorn et al. (2004), who suggest that DOM is produced from rather old fractions. Hence, in Daisy DOM is mainly produced from SOM by some physical/chemical/biological processes resulting in that some part of SOM in soil is dissolved. The biological processes, described in this paragraph, release a fraction of metabolites as DOM during microbial degradation of organic matter. When some transformation occurs in the organic matter fractions, for instance by external cellular enzymes or chemical hydrolyses, a water-soluble organic matter fraction is produced. In this way the DOM fraction is related to decomposition of the other organic fractions. Depending on the sources, DOM has variable C/N ratio.

Each organic pool is quantified according to C and N in Daisy. An overview of the individual soil organic fractions and the internal dynamics between the fractions can be viewed in figure 1. As microbes assimilate low molecular-weight compounds, some C is respired to produce energy, and the rest is synthesized into either new tissues (growth) or metabolites that are released to the extracellular environment. The SMB1 and SMB2 are characterized by a substrate utility coefficient, which depends on the microbial community and the bioavailability of the substrate. The substrate utility coefficient refers to the fraction of substrate, which is incorporated into the microbial biomass. The rest is mineralized, releasing CO_2 and inorganic N.

The decomposition of the SOM1 and SOM2 pools is mainly driven by the turnover of SMB1. Microbes selectively degrade the less recalcitrant compounds. Thus, a gradually increase in average recalcitrance of the non-respired C results in, that some fraction of SOM2 enters SOM1. Furthermore, the SMB2 receives C input of death microbes from SMB1 and also from its own population for further decomposition, figure 1.

1.2 Sorption/desorption of DOM

The bulk of the organic matter in most soils is bound to clay minerals, probably through linkages with Fe, Al, and other polyvalent cations (Stevenson, 1994). Evidence from studies in soil systems indicates that sorptive protection of DOM may be of particular importance; hence, according to several authors (e.g McDowell and Wood, 1984; Guggenberger and Zech, 1992; Kaiser et al., 1996; Qualls and Haines, 1992) the change in quantity of DOM during passage through the mineral soil is caused by sorption of DOM on to the soil mineral phase. A first indication of the importance of sorptive protection in soils is the frequently reported positive relationship between organic C content and the clay content (e.g. Burke et al., 1989; Hassink, 1997). Secondly, fluxes of DOC generally decrease from litter layer to deeper mineral horizons and in virtually every soil with substantial clay content, DOC concentrations drop by 50 % - 90 % from the surface organic layers to subsurface minerals soils (Neff and Asner, 2001).

Much evidence suggests that clay somehow stabilizes SOM. Hence, correlations between clay content and accumulation of microbial biomass derived from ^{14}C -glucose (Amato and Ladd, 1992) and SOM content have been obtained (Burke et al., 1989). The quantitative importance of sorption in SOM stabilization and accumulation is even less well understood than the mechanisms and

controls of sorption (Sollins et al., 1996). How much of the OM in soil might be sorbed? Chemisorption of organic matter to clay-sized particles and physical protection of organic matter within organo-clay aggregates often cannot be clearly distinguished (Guggenberger and Kaiser, 2003). It has been hypothesized that a pool of potential DOM exists as a part of SOM “that is not in solution but is part of the soil solids and able to pass into the solution under realistic conditions” (Tipping, 1998 cf. Kalbitz et al., 2000). Hence, according to this hypothesis some part of SOM has potential to release DOM and to ‘remove’ or sorb DOM from solution.

It is often found that soil is able to release DOM when exposed to aqueous solution containing no or very low concentrations of DOM (Kaiser, 2001). Thus, the soil solid phase may not only sorb DOM but may also release it depending on solution DOM concentrations. The quantitative importance of sorption of DOM in stabilization and accumulation of SOM could be related to the amount of organic matter associated to clay minerals and sesquioxides, as they provide the vast majority of sorbent surface area in soil. Extraction of DOM from soil bulk samples using a chelating reagent, which had a high affinity for polyvalent cations, released approximately 50 % of the organic matter in the soil to the solution phase (Gjettermann et al., 2005). This fraction of extracted DOM is released by removing polyvalent cations as Fe^{3+} , Al^{3+} from SOM. This could indicate that approximately half of the SOM was associated to polyvalent cations and could be a potential pool of DOM able to pass into the solution if released. These findings are in accordance with Greenland (1971) who observed that 52-98 % of the C in soil examined was associated to clay minerals.

In Daisy it is considered, that DOM is rather old organic substance, assuming that easily degradable new components are rapidly consumed by microbes and can not be distinguished from the AOM pools. Hence, DOM is mainly produced from SOM by some physical/chemical/biological processes resulting in dissolution of part of SOM in the soil. Based on the above mentioned observations of DOM extraction and amount of SOM associated to minerals, it is assumed that the relative bioavailable fraction of SOM, the SOM2 pool, has potential for releasing DOM to or removing DOM from solution. Only the SOM2 pool contributes to the sorptive preservation or destruction of organic substances, as SOM2 is the most bioavailable and less stabilized fraction of SOM. Additionally, the quantity of SOM2 often approximates to be 1/3 of total SOM.

1.2.1 DOM sorption/desorption at equilibrium

Desorption and sorption of DOC has been described by an approach called the Initial Mass isotherm. It is developed and described by Nodvin et al. (1986) for a number of anions and DOC. The Initial Mass (IM) isotherm is a simple partitioning model that additionally accounts for the substance initially present within the soil. In several studies IM isotherms have been able to describe the amount of DOC, removed or released to the solution by the soil, as a linear function of the initial amount of DOC added to the soil-water system (Moore et al., 1992; Vance and David, 1992; Guggenberger and Zech, 1992). It has also been able to describe the exchange of dissolved organic P (DOP) (Kaiser, 2001) and dissolved organic N (DON) (Kaiser and Zech, 2000) using the IM isotherm.

In the IM isotherm the amount of substance sorbed or released (normalized to soil mass) is termed *RE*. Negative values of *RE* indicate a net release to the solution, and a positive value indicates a net removal of substance from the solution. It is not a measure of totally sorbed substances, for additional substance may have been present within the soil at the beginning of an equilibration experiment. A linear function is obtained when plotting the amount of solute (normalized to soil mass) removed from or released to the soil solution as a function of amount of solutes (normalized to soil mass) added to the soil:water system (Nodvin et al., 1986). When *RE* is plotted as a function of the added amount of that substance X_i (normalized to soil mass), the release or removal, *RE*, of DOC is given by:

$$RE = mX_i - b \quad \text{eq. 1-1}$$

RE: Amount released or removed from solution after 24 hours [g kg⁻¹]
X_i: Amount of substance added [g kg⁻¹]
m: Partitioning coefficient or slope of linear regression [g g⁻¹]
b: Intercept of linear regression [g kg⁻¹]

The slope of the linear function, *m*, is related to the partitioning coefficient and is a measure of the affinity of the substance to the sorbent. The numerical value of *m* represents the fraction of substances in the soil:water system that is associated with the soil (Nodvin et al., 1986). The intercept of the linear regression, *b*, represents the amount of substances released from or sorbed by the soil when a solution with no sorbate (DOM) is added. Thus, the intercept may be called a desorption term. The relationship is consistent with a simple partitioning of DOM between soil and solution with *m* as a partitioning coefficient.

In a sorption experiment, the amount of solute remaining in solution is the difference between the amount added and the amount removed or released by the soil. The plot of *RE* as a function of the final amount of substance, *X_f*, is equivalent to an IM isotherm given by eq. 1-1, in which the abscissa has been rescaled by the variable *RE*. The axes *RE* and *X_f* are not independent, because both parameters are dependent upon *X_i* (*X_f* = *X_i* - *RE*).

To utilize the IM isotherm, the concentrations used in sorption experiments must produce data that result in a statistically linear fit to the IM isotherm. Use of the IM isotherm will therefore be precluded above a certain solute concentration, which will vary depending on the soil, substance, and experimental conditions (Nodvin et al., 1986). In a batch sorption experiment, the pH-dependent sorption of DOM to an agricultural top- and subsoil was conducted with two pH levels (pH 5 and 7). For the range of DOC concentration of 0-56 mg L⁻¹, the IM isotherm was able to describe the DOC sorption isotherms with correlation factors *r*² >0.9 (Gjettermann et al., 2004). DOC concentration obtained by suction cups for the same soil as used in the sorption experiments varied between 17 and 45 mg L⁻¹ for the topsoil and 5 and 16 mg L⁻¹ for the subsoil (Vinther et al., 2005b). This is in the range of reported DOC concentrations in agricultural soils varying from 3 to 70 mg L⁻¹ (Zsolnay, 1996). Other batch experiments with forest soil have used DOC concentrations up to 81 mg L⁻¹ (Moore et al., 1992) and found good correlation factors in fitting the IM isotherm.

A number of sorption studies of DOC sorption have indicated that extractable Fe and Al, organic C content, and mineralogy are important controls on the ability of soils to sorb DOC, (McDowell and Wood, 1984; Moore, 1989). Moore et al. (1992), Kaiser et al. (1996), and Neff and Asner (2001) have attempted to estimate correlations between soil properties and parameters of the IM isotherm to describe DOC sorption in general terms for different soils. In these simulations, the pedotransfer functions used for estimating the two parameters, *m* and *b* are developed by Moore et al. (1992):

$$m = 0,451 + 0,02 \log(Fe_{dcb}) + 0,032 \sqrt{Al_{ox}} + 0,064 \log(OC) \quad \text{eq. 1-2}$$

$$b = 0,145 + 0,103 \log(OC) - 0,055 \sqrt{Al_{ox}} - 0,045 \log(Fe_{dcb}) \quad \text{eq. 1-3}$$

OC: Organic C, [%].
Al_{ox}: Oxalate extractable Al, [%].
Fe_{dcb}: Dithionite-citrate-bicarbonate extractable Fe, [%].
b: Desorption parameter in g kg⁻¹.
m: Partitioning coefficient with unit in fraction.

These functions, eq. 1-2 and eq. 1-3, were found to be able to describe IM isotherms of measured DOC sorption experiments for an agricultural soil located at Burrehøjvej, Foulum Research Centre (Gjettermann et al., 2004). The IM isotherms estimated by the parameters from the pedotransfer functions by Moore et al. (1992) were in between the measured sorption data at pH 5 and pH 7 for all three horizons, figure 2.

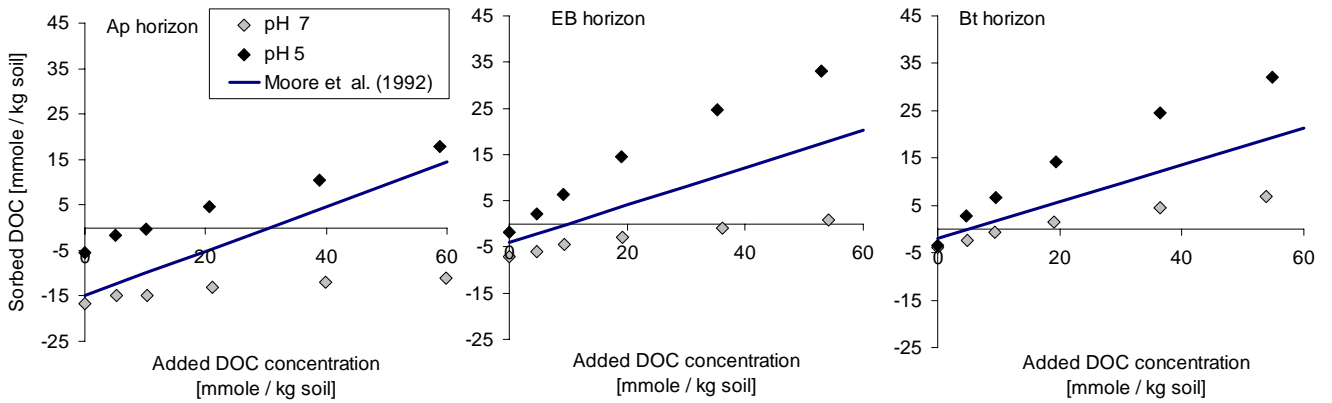

Figure 2. DOC sorption IM isotherms estimated by the pedotransfer functions developed by Moore et al. (1992) (line), together with measured sorption data at pH 5 and pH 7 (dots) for the Ap, EB, and Bt horizons located at the Burrehøjvej field at Research Centre Foulum, respectively.

At this stage the pH effect is not incorporated into the sorption parameters, as insufficient data are available linking the pH effect to the sorption parameters of the IM. Hence, the best fit to describe the measured DOC sorption experiments was taken to be right in between the observed data at pH 5 and 7.

1.2.2 Null-point concentration of DOC

The DOC sorption isotherm described by the IM isotherm is the amount of DOC sorbed or released after 24 hours of reaction. When no DOC is removed from or released to the solution then $RE = 0$. Inserting $RE = 0$ into eq. 1-1, the amount of DOC in solution (normalized to soil mass) at this point, DOC_{np} , is given by eq. 1-4.

$$DOC_{np} = \frac{b}{m} \tag{eq. 1-4}$$

DOC_{np} : The null-point concentration of DOC [$mg\ g^{-1}$].

The null-point concentration of DOC, at which there is no net removal or release of DOC from the solution, is then given by the intercept of the x-axis on the IM isotherm. This point corresponds to the change in DOC after 24 hours of reaction in the soil:water system. Figure 3 schematizes the IM isotherm and the null-point concentration of DOC where there is no net removal or release of DOC.

The sorbed phase is considered to be a large proportion of SOM. The sorbed phase is then an infinitely large sink and source of DOM in the topsoil. When describing DOM sorption by the IM isotherm, the sorbed phase is not a limiting factor for DOM sorption or desorption capacity. This implies that only the DOM concentration in the soil solution determines whether sorption or desorption occurs. To avoid that the DOM sorption/desorption process description continues to only desorb DOM from SOM, emptying the SOM pool, or the opposite, it is assumed that the soil seeks to equilibrate the solution concentration towards the DOC_{np} . The parameter DOC_{np} is

considered to be constant with time; however, changing land use markedly might influence DOC_{np} . Hence, the DOC_{np} is considered to be the soil:water systems optimum DOC concentration at equilibrium, $DOC_{eq_optimum}$, that the soil system will approach with time.

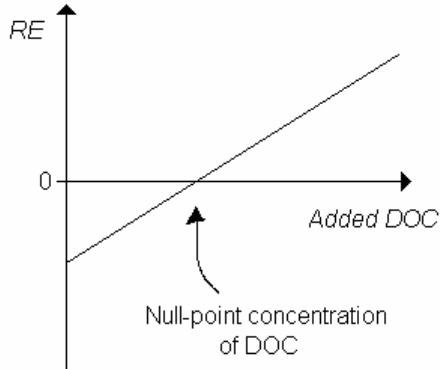

Figure 3. The Initial Mass isotherm.

However, this null-point concentration which is normalized to soil mass is established at soil:water ratios of 1:10 in sorption batch experiments (Moore et al., 1992). Transferring the DOC_{np} from per soil mass units to per soil solution unit is done by taking this soil:water ratio into account.

$$DOC_{eq_optimum} \approx DOC_{np} \frac{m_{batch}}{V_{batch}} \quad \text{eq. 1-5}$$

$DOC_{eq_optimum}$: Optimum concentration of DOC in solution at equilibrium [$g L^{-1}$].

DOC_{np} : The null-point concentration of DOC [$g kg^{-1}$].

m_{batch} : Soil mass in batch system [kg].

V_{batch} : Volume of solution in batch system [L].

According to this, the IM isotherm is used for estimating a DOC concentration optimum in the soil solution, a concentration the soil system will approach with time.

1.2.3 The kinetic approach of DOM sorption

It is assumed that the least recalcitrant pool of soil organic matter, the SOM2 pool, has potential for release of DOM to or removal of DOM from solution. The system of dissolved phase and solid phase is then described as:



$SOM2$: Bioavailable fraction of soil organic matter [$g kg^{-1}$].

DOM : Dissolved organic matter [$g L^{-1}$].

k_1 : First order sorption rate coefficient [$hour^{-1}$].

k_2 : First order desorption rate coefficient [$hour^{-1}$].

The exchange between the dissolved and solid phase is described by a first order reaction as it is assumed only to depend on the solute concentration. However, it couples the defined optimum for DOC concentration to the actual DOC concentration. The kinetics must be considered as an empirical, kinetic expression (eq. 1-7) linking the difference in concentration between wanted and

actual conditions in the soil. Hence, in a very simplified view it lumps together considerations as diffusion and sorption kinetics into the description of the sorption/desorption process, as it is not possible at present to incorporate consideration of variables such as pore geometry and particle surface availability into the model.

The 'reaction rate coefficients' k_1 and k_2 in eq. 1-6 are constants. The kinetics concept describes the sorption and desorption as functions of the difference between the solute and the optimum concentration and a rate coefficient. The change of amount of sorbed DOC is given by eq. 1-7.

$$\frac{dDOC_{sol}}{dt} = \begin{cases} -k_1(DOC_{sol} - DOC_{eq_optimum}), & DOC_{sol} - DOC_{eq_optimum} > 0 \\ -k_2(DOC_{sol} - DOC_{eq_optimum}), & DOC_{sol} - DOC_{eq_optimum} \leq 0 \\ 0, & SOM2 < 10^{-9} \end{cases} \quad \text{eq. 1-7}$$

DOC_{sol} : Actual concentration of DOC in solution [$g L^{-1}$].

k_1, k_2 : Rate constants [$hour^{-1}$].

$\frac{dDOC_{sol}}{dt}$: Change of DOC with time t [$g L^{-1} hour^{-1}$].

Depending on whether the DOC concentration is above or below the optimal concentration, $DOC_{eq_optimal}$, desorption or sorption is activated. However, the processes of sorption and desorption are activated if there is DOM or SOM in the soil. For instance, in the subsoil SOM may limit desorption of DOM, if the amount of SOM is below a critical value. During sorption and desorption of DOM, the change in DOC is correlated by the change of C in the SOM2 pool. The change in DON depends on the C:N ratio of the SOM2 pool if desorption occurs. If sorption occurs, the change of DON depends on the C:N ratio of the DOM pool. Hence, the C:N ratio of the source determines the change of N in the sink.

1.3 Parameterization of DOM module

The parameterization of DOM sorption/desorption rate constants, k_1 and k_2 in eq. 1-7 was calibrated using the batch sorption experiments described in Gjettermann et al. (2005). The soil used is located at the Burrehøjvej field at Research Center Foulum in the central part of Jutland, Denmark (9°34'E, 56°29'N). In the previous 9-years (1994-2002) the soil has been covered by grass-clover and grassed by dairy cattle approximately 150 days per year. The soil is classified as a Humic Hapludult (Soil Survey Staff, 1999). Bulk soil material was sampled every 20 cm from the surface to 130 cm depth; samples from the genetic Ap, EB, and Bt horizons were collected from appropriate depths. For pedogenetic analyses, air-dried soil passed through a 2 mm sieve was used. Selected data are listed in table 1.

Table 1. Soil characteristics of Burrehøjvej field.

	Ap horizon	EB horizon	Bt horizon
pH	5.68	5.75	4.27
	----- cm -----		
Depth	0-30	30-70	70-130
Particle sizes:	-----g kg ⁻¹ -----		
< 2 μm	68	126	148
2-20 μm	127	114	97
20-200 μm	554	524	544
200-2000 μm	251	236	211
Nutrients:	-----g kg ⁻¹ -----		
Total C	30.10	1.41	0.76
Total N	2.01	0.09	0.05
Total P	0.80	0.41	0.23
Aluminium and iron fractions:	----- mmole kg ⁻¹ -----		
Al _{cbd} [†]	133	115	71
Al _{ox} [‡]	111	81	62
Fe _{cbd}	80	77	83
Fe _{ox}	62	22	32

†: *cbd* acronym for citrate-bicarbonate-dithionite. ‡: *ox* acronym for oxalate.

For the sorption experiments, moist soil stored in the refrigerator were used. The water content of the soil material was measured by drying at 105 °C every time a sorption experiment was performed. A stock solution of DOM to be used in the sorption experiments was prepared by extraction of the A-horizon material using a chelating, sodium saturated resin, Chelex® 100 Resin (from Bio-Rad). Six series of sorption experiments were conducted with two pH levels (pH 5 and 7) for each of the Ap, EB, and Bt horizons. A sorption series comprised six bottles (250 ml Blue Cap) with a soil:solution ratio of 1:10, and with initial concentrations of DOM of 0, 0.4, 0.8, 1.7, 3.4 and 4.7 mmol C L⁻¹, respectively. A 10 mM NaCl solution was used as background electrolyte throughout, and all sorption experiments were carried out in duplicate. Further details of the sorption experiments and the extraction procedure are described in Gjettermann et al. (2004, 2005).

When the rate constants, k_1 and k_2 , equal 1 h^{-1} , the sorption/desorption process are instantaneous, achieving equilibrium immediately, which is given by the $DOC_{eq_optimum}$. Depending on whether the DOM concentration is above or below the $DOC_{eq_optimum}$, then the DOC concentration in the soil is reduced or increased, respectively. Reducing the sorption/desorption rate coefficients, the exchange between the SOM2 and DOM pool is reduced. The best fit of simulations to measured DOC concentrations in batch experiments was found by using desorption and sorption rate coefficients of 0.001 hour^{-1} . The calibration results of the batch experiments applying 0-4.7 mM DOC to a soil:solution system of 1:20 are shown in figure 4. The top curves in the simulations correspond to the highest concentration levels applied; the next curves correspond to the next concentration applied, and so on.

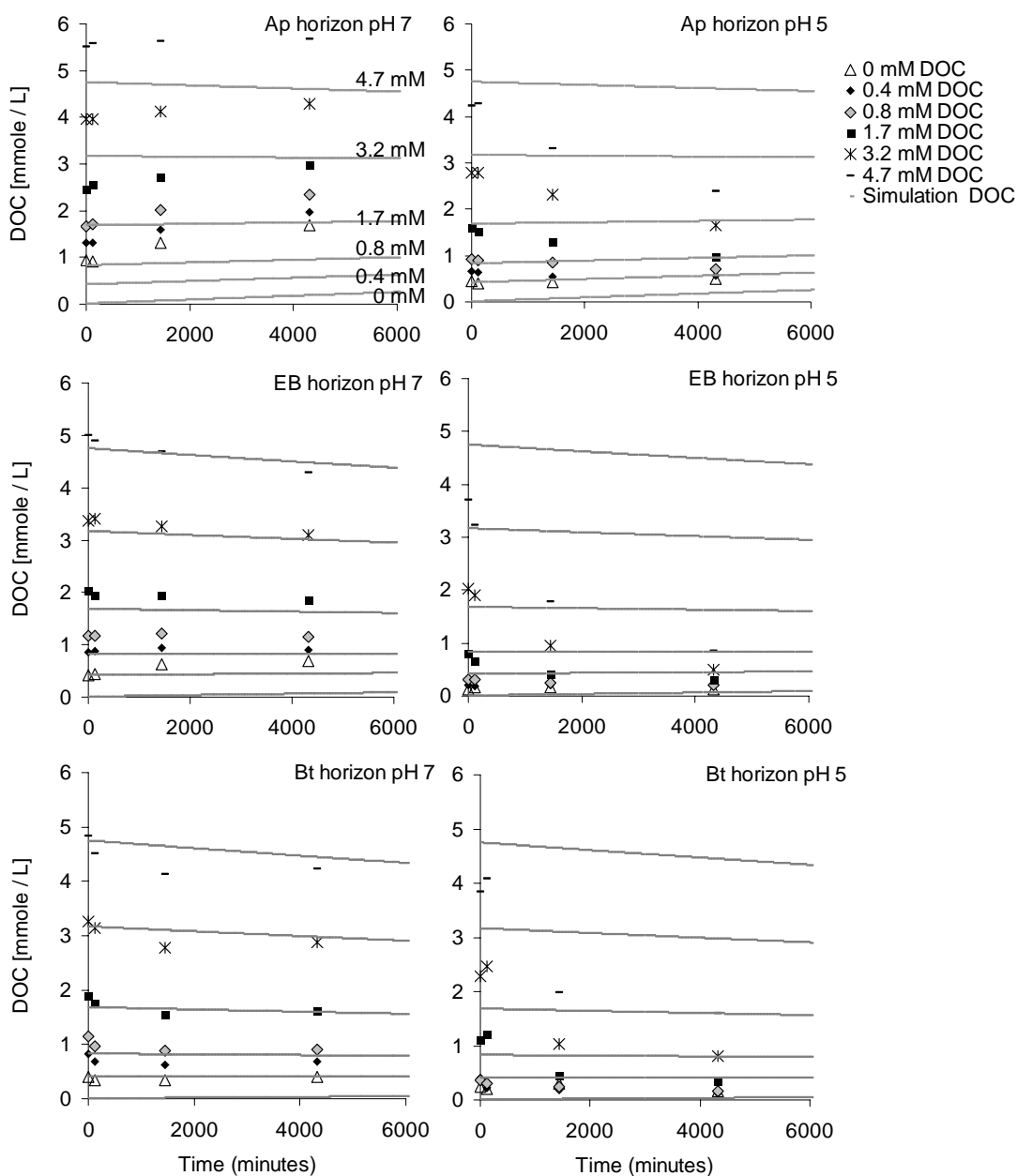

Figure 4. Calibration of DOC sorption with measured data of batch experiments using reaction rate constants $k_1 = k_2 = 0.001$ per hour.

A notable effect of pH was observed in the sorption experiments. The simulated DOC concentrations are slightly underestimated at pH 7 and overestimated at pH 5, especially at high concentration levels. The effect of pH is not included in the DOM module at this stage as not enough data were available to parameterise the pH effect. However, this should be improved in order to simulate DOM sorption/desorption in soil. At pH 5, the sorption is very quick during the first 24 hours, then the sorption rate declines. In order to simulate this correctly, perhaps two DOM pools may be considered with different sorption rates. However, this is out of scope at this stage. The best fit to sorption data was assumed to be in between pH 5 and pH 7, as the initial soil pH was in between for the Ap and EB horizons, table 1. The best fit of simulations to measured DOC concentrations in batch experiments was found by using rate constants $k_1 = k_2$ of 0.001 hour^{-1} .

Several experimental studies have been considered in relation to parameterization of the organic matter module in Daisy, both long-term field experiments and short-term incubation experiments with different applied organic fertilizer. The organic matter module is reviewed in (Jensen et al., 2001). The parameter values in table 2 have been used for the SOM and SMB pools. Including modeling of DOM turnover in the organic matter module, this pool also has to be parameterized in relation to organic matter turnover.

Table 2. Standard parameterization values in Daisy and DOM parameters for the organic matter module described in figure 1.

	SMB1	SMB2	SOM1	SOM2	DOM [§]
C/N-ratio	6.7	6.7	11	11	Variable
Partitioning coefficient, f_x	0	1.0	0.1	0.4	0.05
Microbial efficiency, E	0.6	0.6	0.4	0.5	0.5
Death rate coefficient, d^* [day^{-1}]	$1.85 \cdot 10^{-4}$	$1.0 \cdot 10^{-2}$			
Maintenance, m^* [day^{-1}]	$1.80 \cdot 10^{-3}$	$1.0 \cdot 10^{-2}$			
Standard decay rate coefficient, k_x^* [day^{-1}]	$1.98 \cdot 10^{-3}$	$2.0 \cdot 10^{-2}$	$2.7 \cdot 10^{-6}$	$1.4 \cdot 10^{-4}$	$3.6 \cdot 10^{-3}$

It is assumed that DOM is produced by the SMB1, SMB2, and SOM2. The contribution of these pools to DOM production is not fully understood, and therefore the partitioning fractions to the DOM pool are assumed to be equal. The organic matter transformation and the partitioning fractions are schematized in figure 1. The size of the SOM2 pool is significantly higher than the SMB pools; the SOM2 pool therefore has the largest contribution to DOM production.

At this stage, DOM production is not directly linked to the AOM pools, which represent fresh litter, dead roots, and organic fertilizer. The contribution of DOM from all these different AOM pools is probably very different and not possible to parameterize. However, these AOM sources are very bioavailable to the microbial biomass promoting fast turnover and growing microbial biomass, which contributes to the production of DOM. Hence, despite that DOM is not directly produced by the AOM pools, the DOM dynamic is very closely linked to the dynamic of the AOM pools by the microbial biomass. The microbial efficiency of DOM is parameterized like the SOM2 pool, as this pool is an important contributor to the biological and physical/chemical production / destruction of DOM.

Initial rates of DOC decomposition in incubation experiments are generally rapid but then decline quickly to a lower, constant rate (e.g. Zsolnay and Steindl, 1991). A number of references have been found to correlate the rate at which DOM is decomposed with a first order rate constant. The turnover rate was calibrated to a value of $3.6 \cdot 10^{-3} \text{ day}^{-1}$ by fitting simulations of DOM concentrations to measured field data at the Burrehøjvej field (see next paragraph). From agricultural soils, turnover rates of water extracted organic matter have been found to be in the

range of $6 \cdot 10^{-3} - 10 \cdot 10^{-3} \text{ day}^{-1}$ (Zsolnay and Steindl, 1991). Turnover rates of cow faeces have been reported to be in the range of $2.9 \cdot 10^{-3} - 8.5 \cdot 10^{-3} \text{ day}^{-1}$. Thus, the calibration resulted in a relatively low turnover rate indicating that DOM may be relatively recalcitrant to degrade. This is in accordance with the DOM concept so far, as no input is given from root exudes or added organic fertiliser. It is assumed that the easily available fraction of DOM from these sources is degraded very quickly and does not contribute to the mobile DOM fraction.

1.4 Calibration of DOM module

Three fields located at the Burrehøjvej field at Research Center Foulum in the central part of Jutland, Denmark ($9^{\circ}34'E$, $56^{\circ}29'N$) have been used for studying DOM leaching at field scale with different soil treatments. Suction cups were installed in the three fields at 30 cm, 60 cm and 90 cm depth. For further information of the field experiments, see Eriksen (2001), Eriksen et al. (2004), and Vinther et al. (2005b). These field experiments have been used to calibrate the DOM module in Daisy.

1.4.1 Hydraulic and textural properties

Textural data and soil content of organic matter (humus) plus aluminum and iron fractions are listed in Table 1. Measured hydraulic properties at the Burrehøjvej fields are listed in table 3 and estimated hydraulic properties by the HYPRES function are listed in table 4. For the soil horizons below 70 cm, the HYPRES function calculates the parameters for the van Genuchten retention curve model and the hydraulic conductivity curve based on the Mualem theory.

No data are available for the groundwater table at the Burrehøjvej field. However, during soil sampling for textural analysis in February 2003, it was observed that the groundwater table was located at 130 cm depth. Thus, it is assumed that the groundwater table rise to 130 cm during the winter and declines to 180 cm during the summer. The depth of 180 cm is the depth of the second last node in the profile (0-200 cm) and is thereby the lowest depth allowed for the groundwater table in the set-up.

Table 3. Soil hydraulic parameters measured at Burrehøjvej fields (Iversen, 2004). Data are averages of four replicates.

Depth (cm)	Theta residual	Theta saturation	Alpha	n	l	Ks (cm / time)
0-20	0.05	0.573	0.032	1.307	0.500	15.069
20-40	0.05	0.425	0.043	1.307	0.500	4.952
40-60	0.05	0.351	0.022	1.533	0.500	4.666

Table 4. Soil hydraulic parameters estimated by the Hypres function for the Burrehøjvej fields.

Depth (cm)	Theta residual	Theta saturation	Alpha	n	l	Ks (cm / time)
70-130	0.05	0.297	0.055	1.202	-1.485	0.452
130-200	0.05	0.288	0.397	1.191	-1.514	0.288

The measured hydraulic parameters listed in table 3 and the resulting retention curves and hydraulic conductivity curves are illustrated in figure 5 and figure 6.

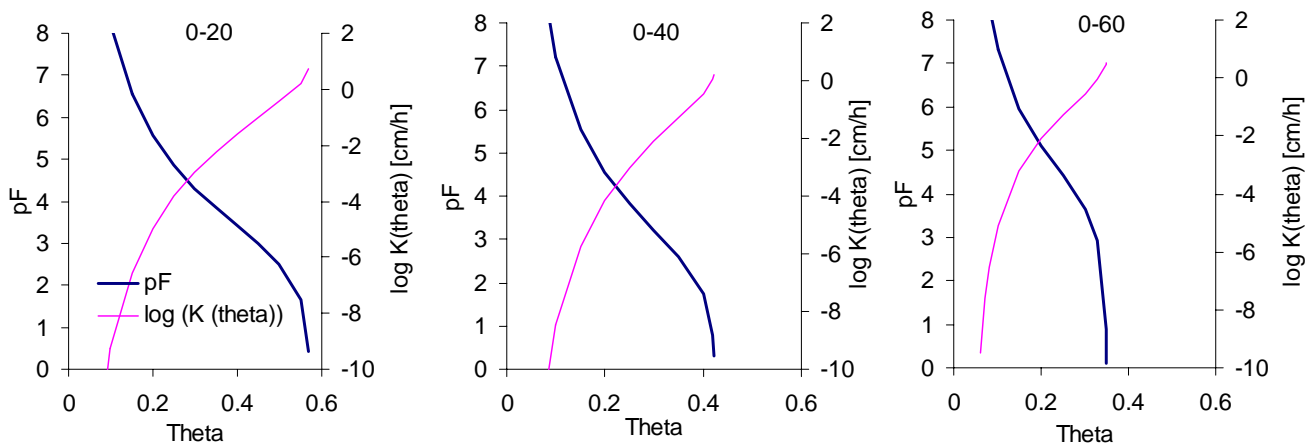

Figure 5. Soil hydraulic functions based on parameters of Table 3.

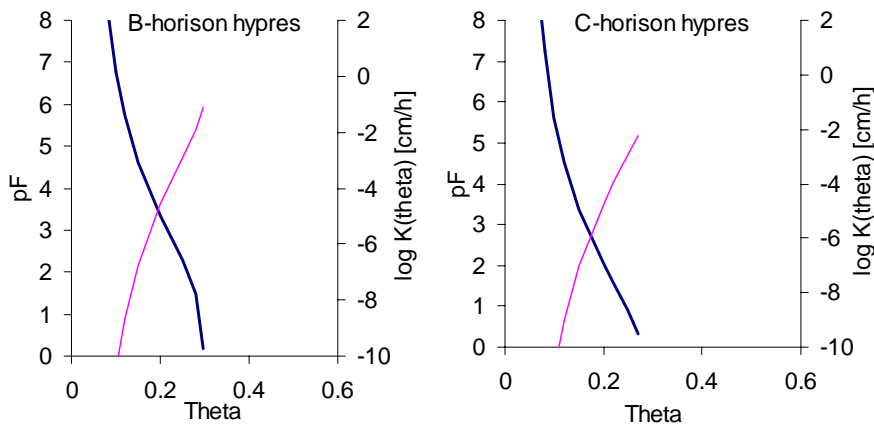

Figure 6. Soil hydraulic functions based on parameters of Table 4.

The transport of DOM in the profile is calculated by solving the convection dispersion equation in Daisy. The diffusion coefficient of DOM, D_{DOM}^* , is assumed to be $6.75 \cdot 10^{-6} \text{ cm}^2 \text{ s}^{-1}$. This is found for DOM in association with commercial humic acid as average between two atomic mass unit fractions of humic acid (Hinedi et al, 1997).

1.4.2 Soil treatments

Three cropping sequences with different grassland frequency and management (table 5) were established in the experimental area for unfertilized grass-clover (perennial ryegrass (*Lolium perenne* L.) and white clover (*Trifolium repens* L.). The 9-year grass-clover treatment has not been ploughed during the last nine years. The 8-year ploughed treatment has been ploughed after eight years of grazed grass-clover. The 1-year ploughed treatment has been in crop rotation and ploughed after one years of grazed grass-clover. The setup files for simulations of the three fields are listed in appendix 1.

In 2002, the soil was rotovated 22nd of March and ploughed 2nd of April. The wheat was sown the 5th of April and harvested 20th of August. In 2002, the dry matter production of harvested wheat was 9267 kg/ha (Vinther et al., 2005b).

Table 5. Soil treatments at the three fields at Burrehøjvej.

Year	1-year ploughed	8-year ploughed	9-year grass-clover
1993	Undersown grass-clover	Undersown grass-clover	Undersown grass-clover
1994	1-year grass-clover (grazed)	1-year grass-clover (grazed)	1-year grass-clover (grazed)
1995	2. Year grass-clover (grazed)	2. Year grass-clover (grazed)	2. Year grass-clover (grazed)
1996	3. Year grass-clover (grazed)	3. Year grass-clover (grazed)	3. Year grass-clover (grazed)
1997	Barley with undersown ryegrass	4. Year grass-clover (grazed)	4. Year grass-clover (grazed)
1998	Wheat with undersown ryegrass	5. Year grass-clover (grazed)	5. Year grass-clover (grazed)
1999	Barley with undersown ryegrass	6. Year grass-clover (grazed)	6. Year grass-clover (grazed)
2000	Barley with undersown grass-clover	7. Year grass-clover (grazed)	7. Year grass-clover (grazed)
2001	1-year grass-clover (grazed)	8-year grass-clover (grazed)	8-year grass-clover (grazed)
2002	Ploughing. Sowing wheat with undersown ryegrass	Ploughing. Sowing wheat with undersown ryegrass	9-year grass-clover (grazed)
Sampling	Wheat stub	Wheat stub	Grass-clover

The grass-clover field is simulated by growing both clover and ryegrass at the same time. The N₂ fixation has been measured in the same field trial as the field for studying DOM leaching at field scale with different soil treatments. In 1994 and 1995, the N₂ fixation was estimated to 232 and 408 kg N ha⁻¹ year⁻¹, respectively (Søegaard et al., 2001). In 1997 and 1998, the N₂ fixation was estimated to 263 and 124 kg N ha⁻¹ year⁻¹, respectively (Hansen and Vinther, 2001). In 2001, the N₂ fixation was estimated to 101 kg N ha⁻¹ year⁻¹ (Eriksen et al., 2004). By sowing only one clover together with ryegrass in the setup, the N₂ fixation was underestimated. It was found that when sowing three clovers at the same time together with only one ryegrass the N₂ fixation was increased to approximately 200 kg N ha⁻¹ year⁻¹, figure 7.

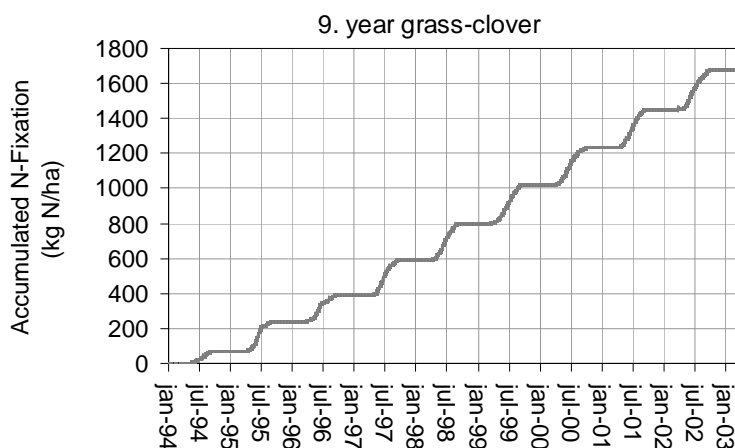

Figure 7. Simulated N₂ fixation by clover in the 9-year grass-clover field.

The fields covered by grass-clover were grazed by approximately 4.8 dairy cattle per hectare during 150 days per year. The calculation of fertilizer input deposited by grazing cows is based on Daisy simulations performed earlier at Burrehøjvej (Pedersen, 2003). The actual amount of dung

and urine deposited in each field by grazing cows is not known. However, from grazing experiments by Søgaard et al. (2001) it is assumed that 70 % of dung and urine per cow is deposited at the field. In 1994, 1995 and 1996 it was found that 233, 307, and 308 kg N ha⁻¹ year⁻¹, respectively, was deposited at the field by grazing cows (Søgaard et al., 2001). It is assumed that the average of N deposited during 1994 -1996 (283 kg N ha⁻¹ year⁻¹) is deposited by grazing cows in the following years.

In the simulations, the grazing cows cut the grass-clover when the crop has reached a certain level of development stage or a dry matter content of 1000 kg DM ha⁻¹. At least 10 days separate the cuts of the grass-clover. When cutting the grass-clover 80 % of leaves, stems, and storage organs are removed from the field and the rest is left as residuals together with 5 cm stub, appendix 1.

1.5 Results of DOM calibration at the Burrehøjvej fields

Besides textural and hydraulic data, weather data on daily basis at the Research Center Foulum are given as input in the setup file, appendix 1. For the simulated period, January 1993 to April 2003, the total precipitation (snow and rain) and the simulated actual evapotranspiration are shown in figure 8.

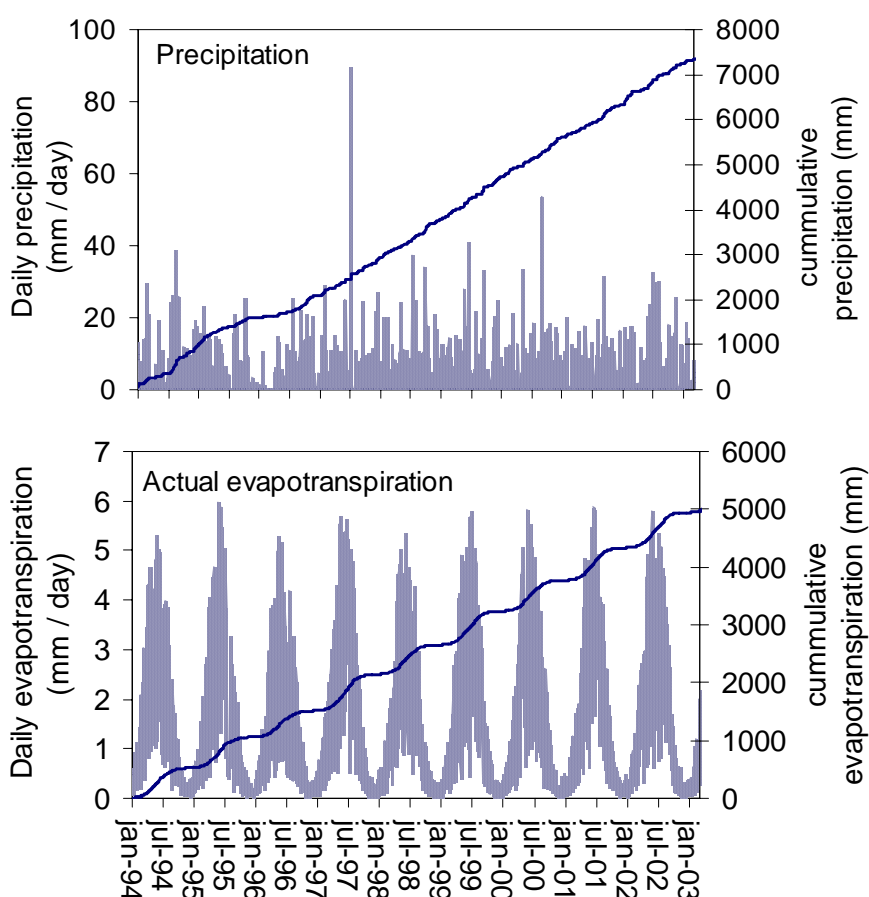

Figure 8. Daily and cumulative precipitation (top) and actual evapotranspiration (bottom) at Burrehøjvej field at Research Center Foulum given by the weather file and calculated by Daisy, respectively.

This corresponds to average yearly values of 820 mm precipitation and 570 mm evapotranspiration during the simulated period, which seems reasonable for the central part of Jutland.

During the period approximately 250 mm per year of water are percolated through matrix (93 % of total percolation) and macropores (7 % of total percolation).

The crop productions of the three different soil treatments (table 5) are shown in figure 9. In 2002 the dry matter production of harvested wheat was simulated to 7800kg/ha and 8300 kg/ha for the 1-year ploughed soil and for the 8-year ploughed soil, respectively. According to measured data 9267 kg/ha was harvested in 2002 (Vinther et al., 2005b), which corresponds well with the simulations, figure 9.

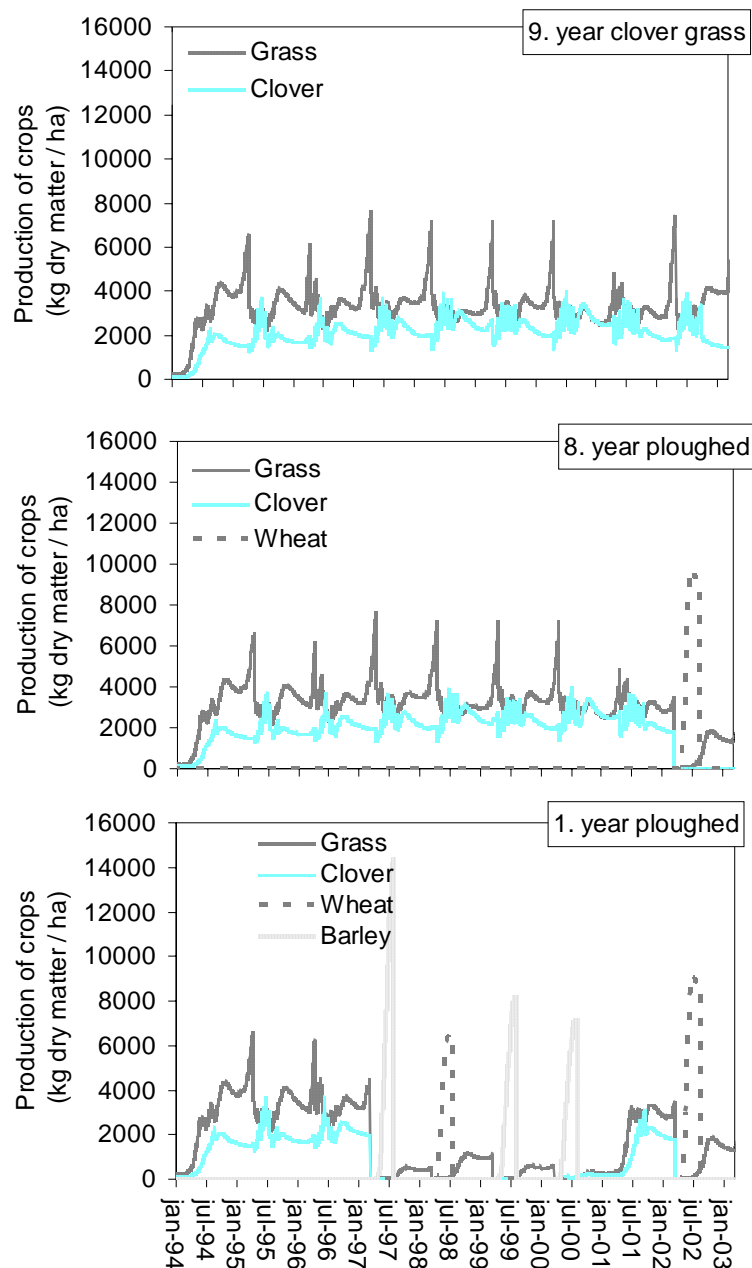

Figure 9. Simulated dry matter production of crops from 1994-2003 in the three fields at Burrehøjvej by the Daisy model. Top figure: 9-years of grass-clover with grazing cows. Middle figure: 8-year of grass-clover then soil ploughing. Bottom figure: 1-year of grass-clover then soil ploughing.

As stated earlier, the turnover rate is calibrated by fitting the simulations at the Burrehøjvej field to the measured data of DOC and DON (not shown) sampled from suction cups at 30, 60, and 90 cm depth of the profiles. The results of the calibration are shown in figure 10 for DOC, in figure 11 for DON, and in figure 12 for NO₃.

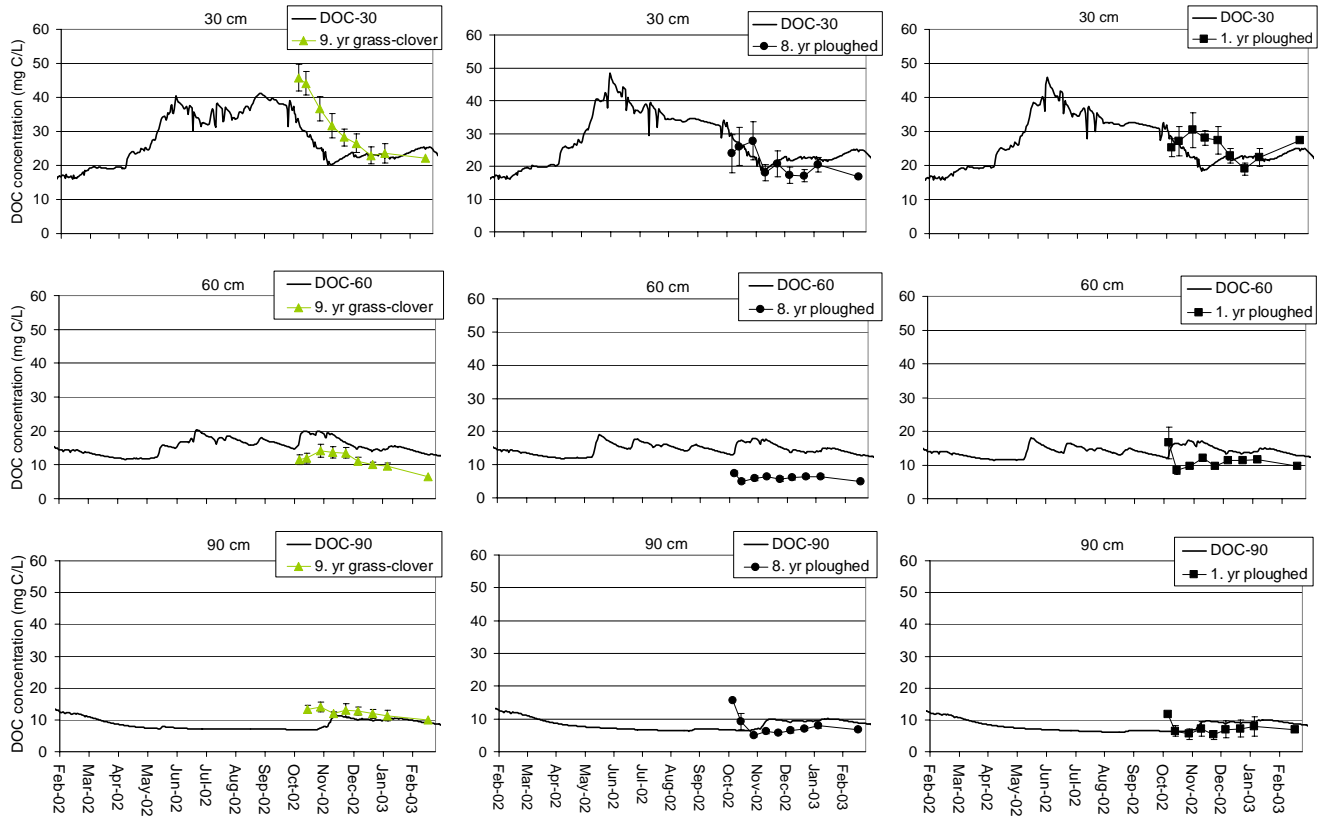

Figure 10. DOC concentration in suction cups (dots) (Vinther et al., 2005b) and simulated by the Daisy code (lines) in the Burrehøjvej field profiles at 30, 60, and 90 cm depth in three soil treatments: left figures: 9-year grass-clover with grazing cows. Middle figures: 8-year ploughed with grazing cows then soil ploughing. Right figures: 1-year ploughed with grazing cows then soil ploughing.

The simulations of DOC and DON concentrations at different depths and with different soil treatments at the Burrehøjvej fields for the last year during sampling are shown in figure 10 and figure 11, respectively. In the topsoil, the DOM is mainly produced by biological SOM turnover during summertime and chemical/physical release from SOM at all time. Thus, the yearly fluctuation of DOM is related to the microbial activity. High fluctuations of DOM, which are produced by microbial activity, are diminished by the chemical/physical sorption/desorption process, which attempts to keep the DOC concentration steady at a certain level. For the 9-year grass-clover field, the DOC fluctuations in the topsoil are diminished in the simulations in relation to the measured DOC concentration. For the two other soil treatments, the DOC concentration show less fluctuations and is better simulated.

At the depth of 60 cm in the fields, DOC and DON concentrations are overestimated for all treatments in the simulations. This could be the reason why the estimated equilibrium concentration of DOC was estimated too high for horizon EB (30-70 cm). However, according to the batch experiments, figure 4, this should also account for the Bt horizon (70-130 cm) as the simulated DOC concentrations in the batch experiments are overestimated at pH 5. But this is not the case at field scale. At 90 cm depth the DOC and DON concentrations are simulated very well for all soil treatments. Thus, the overestimation of DOC and DON concentration in the simulations

at 60 cm is unclear but factors as DOM transport and macropores also affect the DOC and DON concentrations.

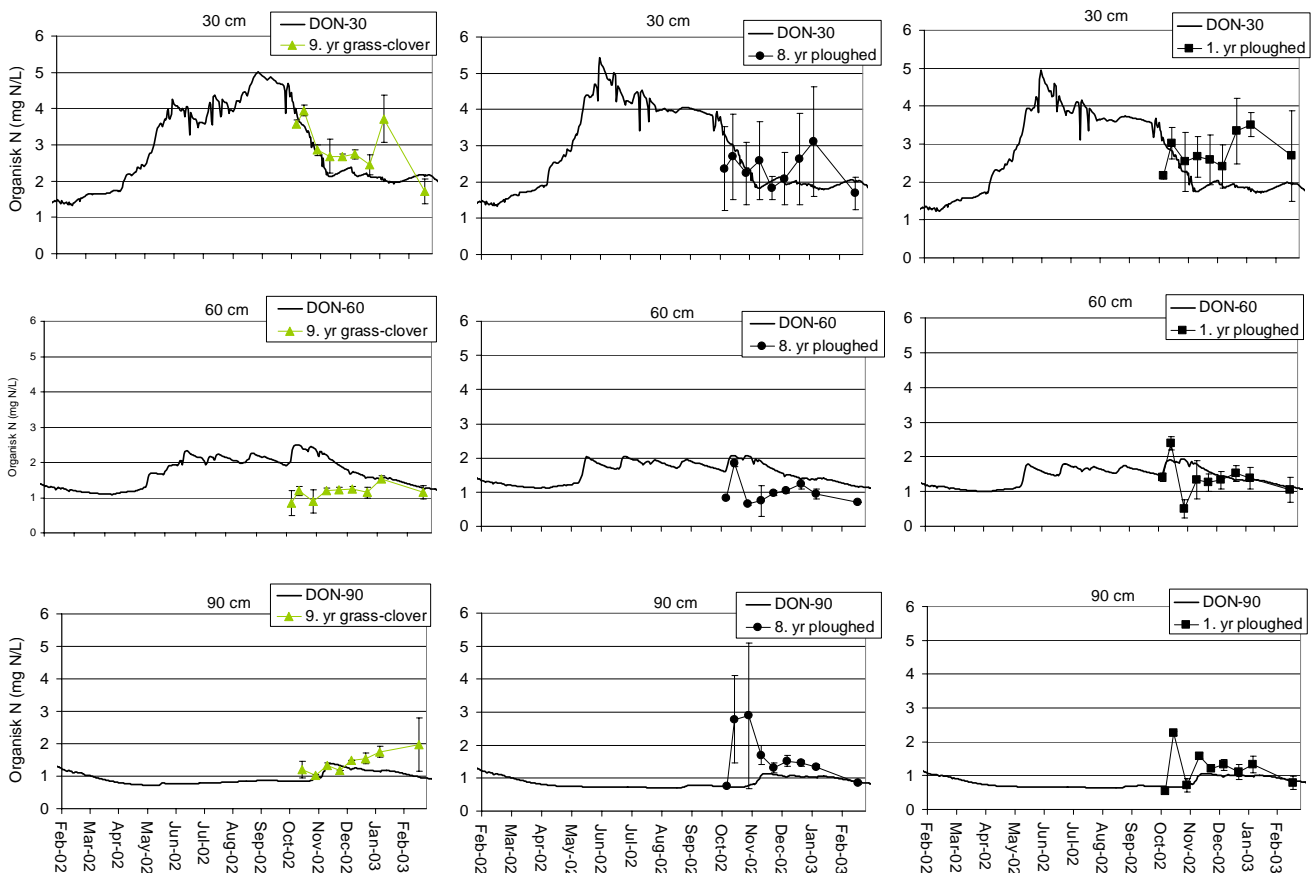

Figure 11. DON concentration in suction cups (dots) (Vinther et al., 2005b) and simulated by the Daisy code (lines) in the Burrehøjvej field profiles at 30, 60, and 90 cm depth in three soil treatments: left figures: 9-year grass-clover with grazing cows. Middle figures: 8-year ploughed with grazing cows then soil ploughing. Right figures: 1-year ploughed with grazing cows then soil ploughing.

Incorporation of grass-clover into the soil by ploughing in March 2002 in the 8-year ploughed and 1-year ploughed fields did not show any effects on the DOM concentration during the sampling period the following autumn and winter. However, during the following spring and summer the simulated DOC and DON concentration topped in May and June due to increased microbial activity of the incorporated grass-clover. High microbial activity of N rich material leads to increased mineralization. Hence, incorporation of grass-clover had considerable effect on NO₃ concentration and dynamics during the following spring and summer, figure 12.

The simulated concentration of NO₃ for the unploughed field, the 9-year grass-clover, is simulated very well regarding concentration levels and dynamic. However, for the ploughed fields the model is very sensitive to the dates of ploughing, sowing, and harvesting. Changing the dates of these activities provided better fits (not shown). The mineralization of the incorporated plant residues and the wheat N uptake is not simulated in agreement with the observed pattern for the field with 8-year ploughed soil. For the 1-year ploughed soil the simulations is better, but still the dynamic for the subsoil are not quite well, figure 12. It is not clear from the measured data of DOC, DON, and NO₃ to whether the incorrect NO₃ dynamics is due to DOM mineralization or due to incorporation of high N rich grass-clover into the soil.

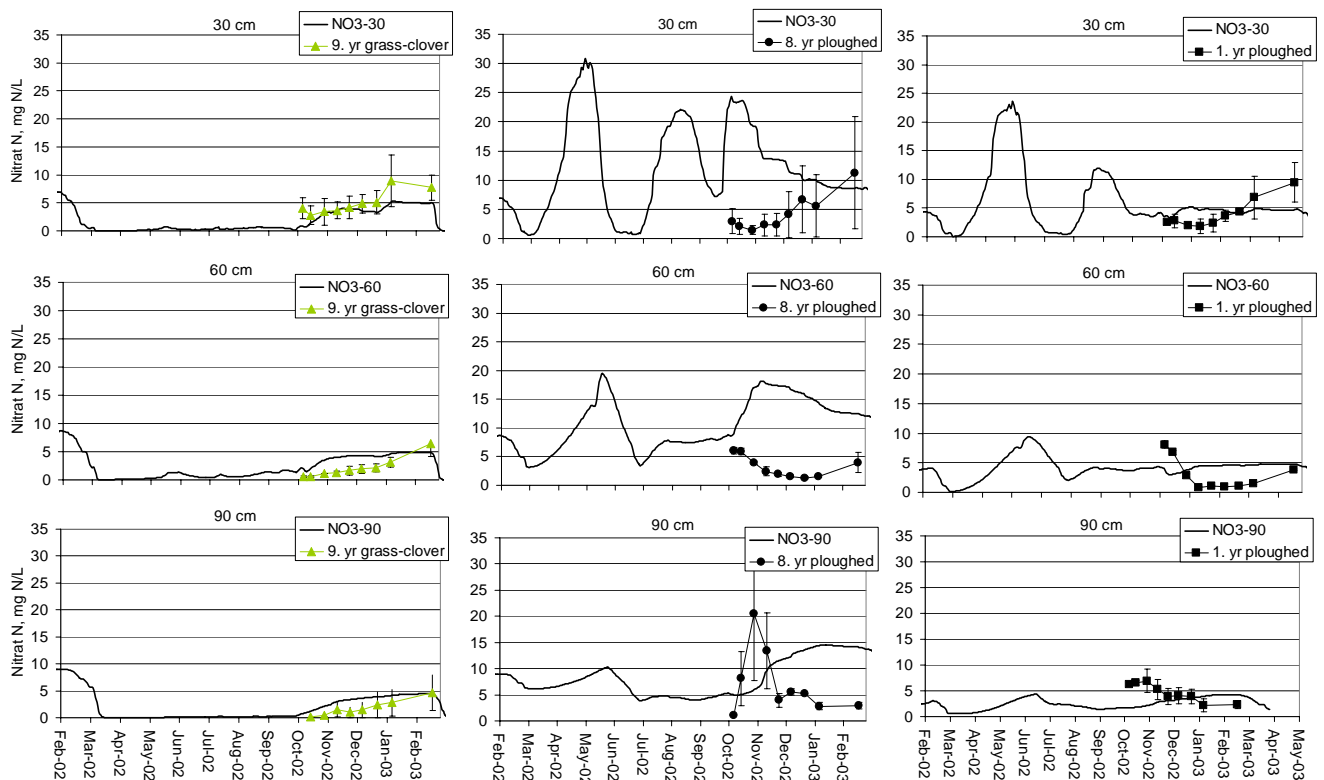

Figure 12. NO_3 concentration in suction cups (dots) (Vinther et al., 2005b) and simulated by the Daisy code (lines) in the Burrehøjvej field profiles at 30, 60, and 90 cm depth in three soil treatments: left figures: 9-year grass-clover with grazing cows. Middle figures: 8-year ploughed with grazing cows then soil ploughing. Right figures: 1-year ploughed with grazing cows then soil ploughing.

1.5.1 Summary of DOM calibration

In the topsoil, the DOM is mainly produced by biological SOM turnover during summertime and chemical/physical release from SOM at all times. The yearly fluctuation of DOM concentration is related to the microbial activity. High fluctuations of DOM which are related to microbial activity are diminished by the chemical/physical sorption/desorption process which attempts to keep the DOC concentration steady at a certain level. For the 9-year grass-clover field, the DOC and DON fluctuations in the topsoil are diminished in the simulations in relation to the measured DOC and DON concentration. For the two other soil treatments, the DOC and DON concentration show less fluctuations and is better simulated.

At the depth of 60 cm in the fields, DOC and DON concentrations are overestimated for all treatments in the simulations. The cause of this overestimation is unclear but factors as DOM transport and macropores also affects the DOC and DON concentrations. At 90 cm depth, the DOC concentrations are simulated very well for all soil treatments.

2 Effect of soil treatment on denitrification and nutrient leaching

From an environmental point of view, leaching of DOM may have beneficial effects by increasing the potential for denitrification (Vinther et al., 2005a). The effect of DOM on the denitrification and total N leaching from two different soils was investigated with respect to:

1. The duration (9, 5 or 2 years) of grass-clover before soil treatment.
2. The time of soil ploughing (spring *versus* autumn).
3. The effect of catch crops.

The soils chosen were Burrehøjvej and Jynde vad fields which are two agricultural soils covered with grass-clover and grassed. The Burrehøjvej field is loamy sand with increasing clay content with depth. Jynde vad is a sandy soil. The Jynde vad field is located in the southern part of Jutland and belongs to an organic farmer. Both soils have both been used for DOM calibration as suction cups were installed in the fields and samples were analyzed for DOC, DON and NO₃. However, the calculations for the Jynde vad field was not acceptable as uncertainties of the approximate number of grassed dairy cattle at the field questioned the amount of organic manures deposited at the field. Additionally, data of texture, hydraulic properties, and Al- and Fe- contents for the Jynde vad field are collected from different sources and not measured directly in the field.

2.1 Root zone parameterization

2.1.1 Hydraulic and textural properties

The textural and hydraulic parameters of the Burrehøjvej field are the same as used for the calibration, paragraph 1.4.1. For the Jynde vad field, hydraulic and textural data including soil organic matter content are collected from Jacobsen (1989). The data of oxalate extractable Fe and Al is collected from Lindhardt et al. (2001), table 6.

Table 6. Soil characteristics of Jynde vad field soil.

	Ap horizon	Bhs horizon	Bs horizon	BC horizon	BC horizon	C horizon
	----- cm -----					
Depth	0-25	25-50	50-85	85-95	95-115	115-200
	----- g kg ⁻¹ -----					
Particle sizes: [§]						
< 2 μm	36	35	26	26	26	26
2-20 μm	47	19	14	5	5	5
20-200 μm	220	147	114	58	58	58
200-2000 μm	674	793	842	909	909	909
	----- g kg ⁻¹ -----					
Nutrients:						
Organic matter [§]	23	6	4	3	3	3
	----- mmole kg ⁻¹ -----					
Aluminium and iron fractions:						
Fe _{cbd} [†]	55	43	28	34	42	27
Fe _{ox} [‡]	29	22	15	18	22	14
Al _{ox} [#]	35	72	53	37	47	24

§: From Jacobsen (1989). †: *cbd* acronym for citrate-bicarbonate-dithionite. ‡: *ox* acronym for oxalate.
#: From Lindhardt et al. (2001).

No data of citrate-bicarbonate-dithionite extractable Fe was available; hence this fraction was calculated from the oxalate extractable fraction by multiplying a factor of 1.9. This relation was estimated as average for 38 observations at Søndersø, Funen.

The measured water conductivity and potential as a function of volumetric soil water content (Jacobsen, 1989) have been fitted to the parameters for the van Genuchten retention curve model with Mualem theory. The fitted hydraulic parameters have been estimated by the RETC model and listed in table 7.

Table 7. Soil hydraulic parameters fitted to measured data at Jyndevad field soil.

Depth (cm)	Theta residual	Theta saturation	Alpha	n	l	Ks (cm / time)
0-25	0,061	0,439	0,057	1,754	0.500	24,3
25-50	0,042	0,438	0,054	2,416	0.500	64,0
50-85	0,028	0,441	0,012	3,469	0.500	77,0
85-200	0,030	0,418	0,054	2,816	0.500	92,5

No data are available for the groundwater table at the Jyndevad field. However, the suction cups installed in 100 cm depth had to be removed to 70 cm depth due to high groundwater level in December 2003. Thus, it is assumed that the groundwater table rises to 100 cm during the winter and declines to 180 cm during the summer. The depth of 180 cm is the depth of the second last node in the profile (0-200 cm) and is thereby the lowest depth allowed for the groundwater table in the set-up.

2.1.2 Soil treatments

The duration of the warm-up period is 10 years, reusing weather data from 1990-2000. During the warm-up period, the soil management is an established crop rotation system used in crop production of organic farming systems, table 8. During the warm-up period, the crop rotation is simulated twice. Except for the grass-clover with grazing cows, all the fertilizer is applied as mineral nitrogen.

Table 8. Crop rotation during the warm-up period.

Crop rotation	Fertilizer application (kg N / ha / year)
Spring barley with grass-clover undersown	94
Grass-clover (grazing, manure)	145 [§]
Oats with ryegrass undersown	75
Wheat with ryegrass undersown	94
Pea with rye undersown	

[§] Fertilizer applied as organic fertilizer by grazing cows.

The crop rotations during the investigated soil treatments are listed for the 9-year grass-clover treatment in table 9, where the spring and autumn soil ploughing are specified in each column. When the soil is ploughed in springtime, then spring barley is subsequently sown with or without catch crop. The catch crop is ryegrass which is undersown one day after spring barley or winter wheat. When the soil is ploughed during the autumn, winter wheat is subsequently sown with or without catch crop. For the 5-year grass-clover and for the 2-year grass-clover, the years 2001-

2004 are simulated like the 9-year grass-clover, table 9; however, the 5-year grass-clover is sown in 1995 and the 2-year grass-clover is sown in 1998.

Table 9. Soil treatment for the 9-year grass-clover for spring and autumn ploughing.

year		Spring ploughing	Autumn ploughing
1991		Sowing spring barley with grass-clover	Sowing spring barley with grass-clover
1992		Grass-clover	Grass-clover
1993		Grass-clover	Grass-clover
1994		Grass-clover	Grass-clover
1995		Grass-clover	Grass-clover
1996		Grass-clover	Grass-clover
1997		Grass-clover	Grass-clover
1998		Grass-clover	Grass-clover
1999		Grass-clover	Grass-clover
2000		Grass-clover	Grass-clover
2001	1 quarter	Grass-clover	Grass-clover
2001	2 quarter	Grass-clover	Grass-clover
2001	3 quarter	Grass-clover	Ploughing
2001	4 quarter	Grass-clover	Sowing winter wheat +- catch crop
2002	1 quarter	Ploughing	
2002	2 quarter	Sowing spring barley +- catch crop	
2002	3 quarter	Harvest	Harvest
2002	4 quarter		
2003	1 quarter		
2003	2 quarter	Sowing spring barley	Sowing spring barley
2003	3 quarter	Harvest	Harvest
2003	4 quarter		
2004	1 quarter		

2.1.3 Output

All three investigated treatments which include the duration of grass-clover, time of soil ploughing, and effect of catch crop are expected to have an effect on N leaching and/or denitrification in the root zone. The effects of the different treatments are investigated by quantifying the net denitrification and net amount of total N lost from the root zone by leaching (0-200 cm) during the period of 1 April to the 31 Marts. Total N is the sum of dissolved inorganic (DIN) as NO₃ and NH₄, and DON. The effect of duration of grass-clover cover is investigated during the autumn and winter 2000-2002. The effect of autumn of soil ploughing is investigated during the autumn and winter 2001-2002, and the effect of spring ploughing is investigated in 2002-2003. Additionally, the effect of catch crop is investigated during autumn and winter 2003-2004.

Denitrification is calculated for the whole profile (0-200 cm) by the amount of microbial conversion of NO₃ to atmospheric N₂ and N₂O during denitrification, which requires anaerobic conditions, plus the amount of N₂O from the microbial nitrification process.

2.2 Effects of soil treatments on soil denitrification and N leaching

2.2.1 Duration of grass-clover cover

Denitrification

The effect of duration of grass-clover covers at the two fields on the denitrification are shown in figure 13, left. For the Burrehøjvej field the denitrification increases from 11,3 kg N ha⁻¹ year⁻¹ for the 2-year grass-clover to 20,7 kg N ha⁻¹ year⁻¹ for the 9-year grass-clover during 2000-2001. The microbial respiration increases from 6400 kg C ha⁻¹ year⁻¹ for the 2-year grass-clover to 7100 kg C ha⁻¹ year⁻¹ for the 5-year grass-clover and 7300 kg C ha⁻¹ year⁻¹ for the 9-year grass-clover. The size of the relatively fast microbial pool, the SMB2 pool, is almost similar for the three durations of grass-clover. However, the relatively slow microbial pool, the SMB1 pool, increases from 1380 kg C ha⁻¹ for the 2-year grass-clover, to 1850 kg C ha⁻¹ for the 5-year grass-clover, to 2050 kg C ha⁻¹ for the 9-year grass-clover where the size of the SMB1 pools is per 1 January 2001. Thus, the increase in respiration in the Burrehøjvej field is due to an increase in the relatively slow microbial pool indicating that a more stable microbial population is established with long durations of clover-grass.

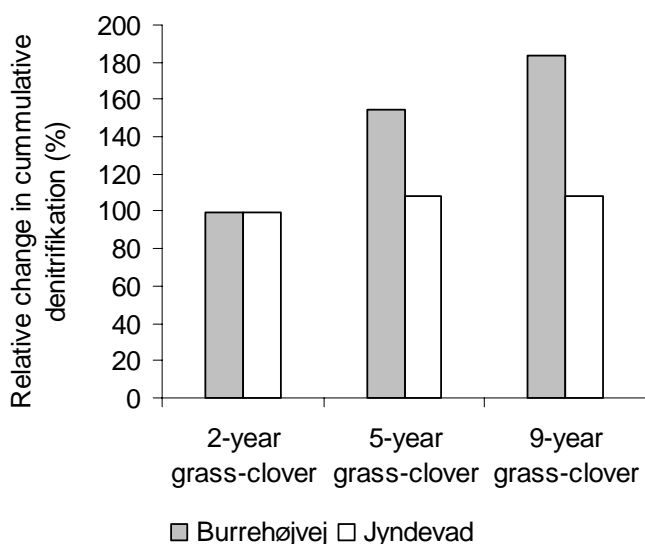

Figure 13. Effect of duration of clover-grass cover on denitrification from the two soils (0-200 cm) during 2000-2001. Relative change in cumulative denitrification compared with 2-year grass-clover.

Together with the increase in respiration with duration of grass-clover, an increase in the DOM content is observed, figure 14. Denitrifying bacteria are heterotrophic organisms which besides NO₃ need an organic C source along with anaerobe conditions to dissimilate NO₃ to NO₂ and thereafter to N₂O / N₂ (Vinther and Hansen, 2004). Thus, the denitrification increases with the increase in duration of grass-clover cover for the Burrehøjvej field. This increase in denitrification is correlated with an increase in microbial activity and DOM content in the soil.

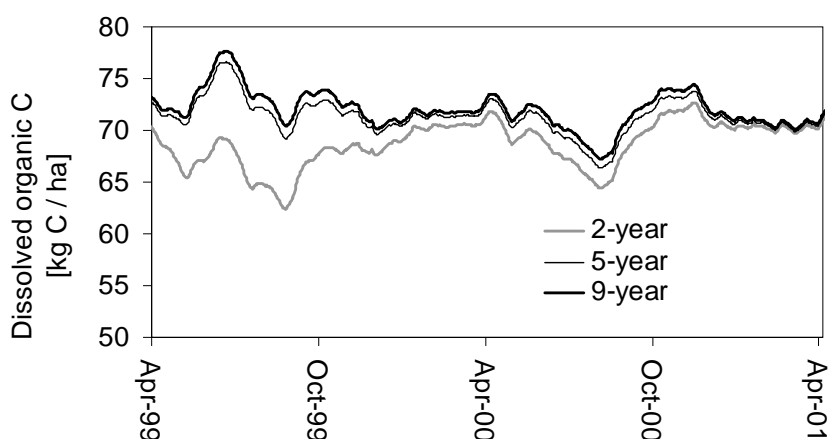

Figure 14. Effect of grass-clover duration on DOC content in the Burrehøjvej soil profile (0-200 cm)

For the Jynde vad field, the denitrification is very small compared to that of Burrehøjvej. The denitrification is almost steady for the Jynde vad field at $1.2-1.3 \text{ kg N ha}^{-1} \text{ year}^{-1}$ for all three durations of grass-clover cover, giving almost no change in the cumulative denitrification, figure 13 left. One of the most important factors for the denitrification is soil water content and pore size distribution as increasing water content reduces air exchange and increases the possibilities for anaerobe zones in the soil (Vinther and Hansen, 2004). The difference between the two soils degree of saturation in the topsoil are shown in figure 15. Due to the difference in pore size distribution between sandy soil and sandy loam soil, the degree of saturation is higher for the Burrehøjvej field in relation to the Jynde vad field and is thereby increasing the potential for denitrification. Hence, the saturation degree of Jynde vad field is too small and limits the denitrification.

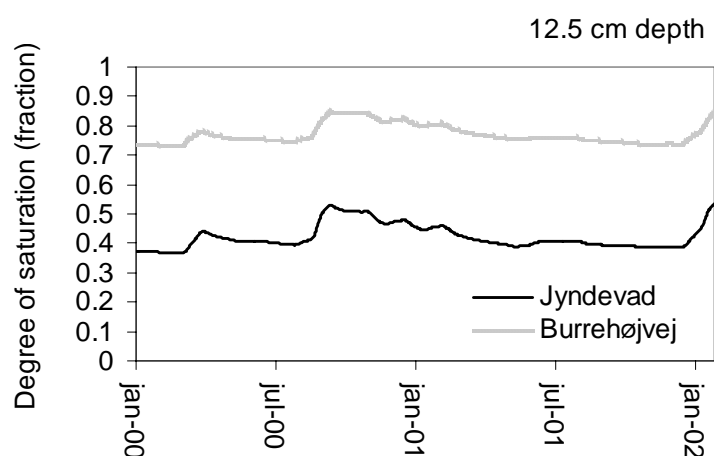

Figure 15. Degree of saturation for the two soil profiles Burrehøjvej and Jynde vad respectively, at depth 12.5 cm during 2000 and 2001.

N-leaching

The effects of duration of grass-clover on N-leaching are shown in figure 16 and table 10. For the Burrehøjvej field, the amount of dissolved inorganic N (DIN) and DON leached from 200 cm depth is very small compared to Jynde vad, table 10.

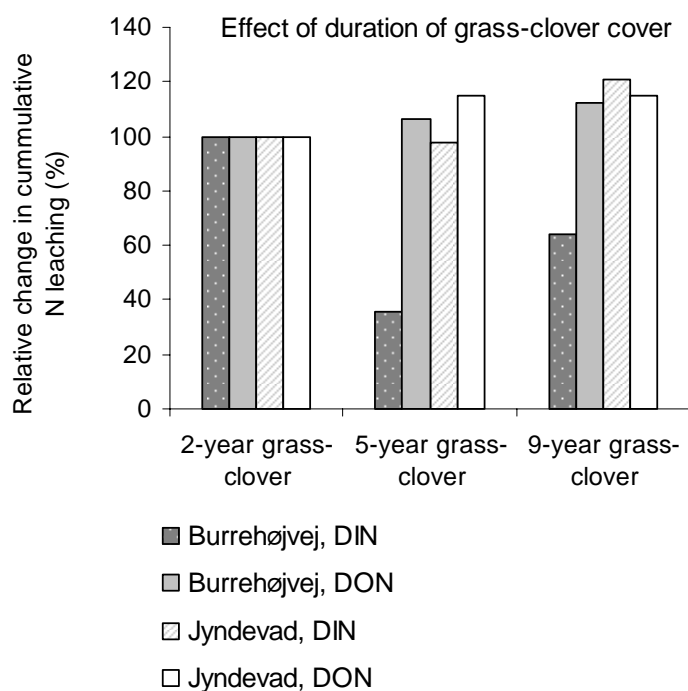

Figure 16. Effect of duration of clover-grass cover on DIN and DON leaching from the two soil profiles (0-200 cm) during 2000-2001. Relative change in cumulative N leaching compared with 2-year grass-clover.

Table 10. Effect of soil and duration of clover-grass on N-leaching, crop uptake and N-fixation ($\text{kg N ha}^{-1}\text{year}^{-1}$) during 2000-2001.

	Burrehøjvej			Jyndeved		
	2-year	5-year	9-year	2-year	5-year	9-year
DIN-leaching	1,4	0,5	0,9	17	17	21
DON-leaching	1,6	1,7	1,8	3	4	4
Crop uptake	282	315	331	276	310	323
N-fixation	278	259	251	288	267	262

The duration of grass-clover does not affect the DIN leaching in a systematic pattern when no soil ploughing occurs. DON leaching increase slightly with increase in duration of grass-clover. Also the crop uptake increases systematically with increasing duration of grass-clover. This affects the N fixation which is reduced when the crop N-uptake increases.

Apparently, the duration of grass-clover in the field does not affect the magnitude of N-leaching when no ploughing occurs. For the Burrehøjvej field the total N leaching is small and DON make up 50-70 % of total N loss. For Jyndeved the total N leaching is considerable larger and DON make up 15-20 % of total N loss.

Figure 17 shows the effects of autumn ploughing on N-leaching of the three durations of grass-clover. In relation to no ploughing, autumn ploughing promotes an increase in DIN-leaching for both fields. DON leaching is not affected by autumn ploughing.

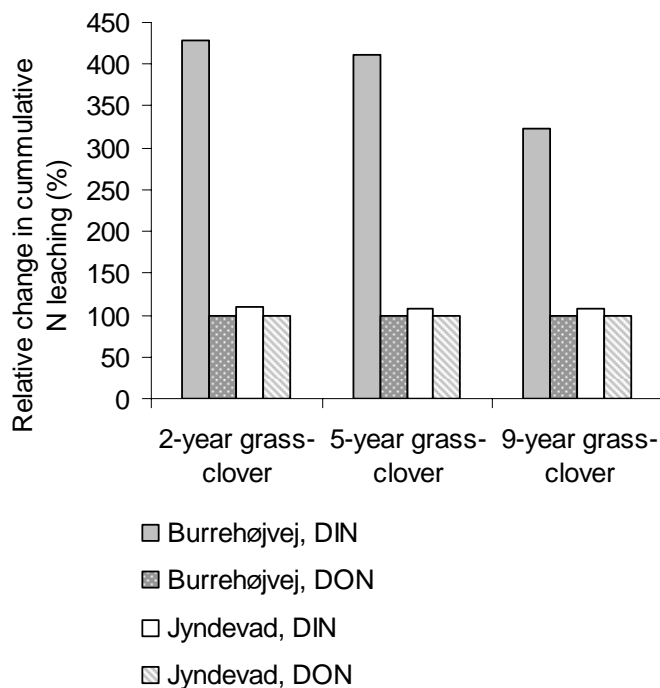

Figure 17. Effect of autumn soil ploughing and duration of grass-clover on N-leaching from the two soil profiles (0-200 cm) during 2001-2002. Relative change in cumulative N leaching compared with no ploughing.

The relative increase in leaching is most apparent for the short duration of grass-clover. However, the magnitude of N-leaching is the opposite. For the Jynde vad field the short duration of 2-year grass-clover leach 23 to 26 kg DIN ha⁻¹ year⁻¹ and for the 9-year grass-clover the leaching is 36-39 kg DIN ha⁻¹ year⁻¹. Same pattern is obtained for the Burrehøjvej field that duration of grass-clover increase the N-leaching after soil ploughing. However, the magnitude of the DIN-leaching is much smaller (1-4 kg DIN ha⁻¹ year⁻¹) for the Burrehøjvej field.

It appears that the duration of grass-clover does not affect the N-leaching as long as no tillage occurs. However, when the field is ploughed for seedbed preparation after grass-clover, then the duration of grass-clover affects the amount of N-leaching.

2.2.2 Time of soil ploughing

Denitrification

The effect of autumn soil ploughing on denitrification of the two fields is shown in figure 18. The effect of autumn soil ploughing and following winter wheat is compared with continuous grass-clover. For the Jynde vad field, neither the autumn nor the spring ploughing affect the denitrification rate and the amount of N denitrified remains at a very low level at 1.2 kg N ha⁻¹ year⁻¹. However, for the Burrehøjvej field, the denitrification increases 26-29 % from approximately 21-23 kg N ha⁻¹ year⁻¹ to 27-30 kg N ha⁻¹ year⁻¹ after autumn ploughing, figure 18.

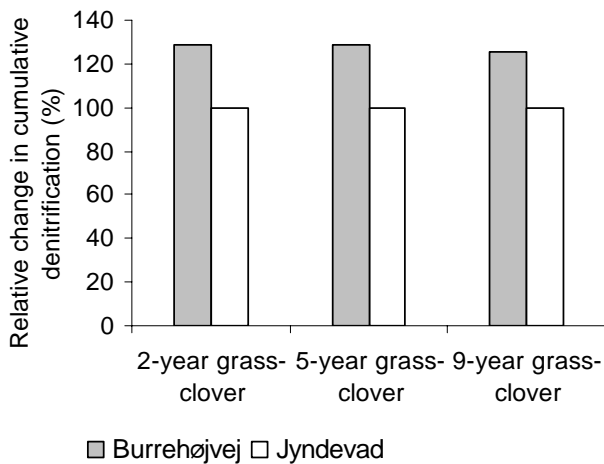

Figure 18. Effect of autumn soil ploughing and duration of grass-clover on denitrification from the two soils (0-200 cm) during 2001-2002. Relative change in cumulative denitrification compared with no ploughing.

The degree of saturation does not change after soil ploughing (not shown), hence the increase is not due to change in relative water content. However, microbial respiration (CO₂-production) increases 6 % during 2001-2002 with autumn ploughing after incorporation of plant residues in relation to the soil with remaining grass-clover.

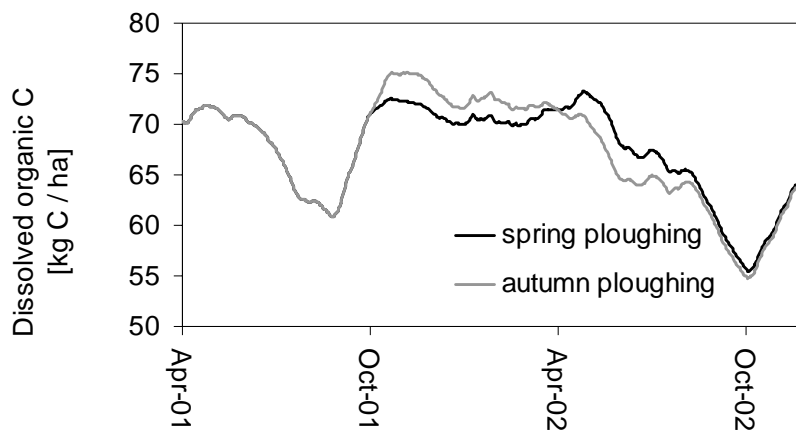

Figure 19. Effect of autumn and spring ploughing on DOC content in the soil profile (0-200 cm) for the Burrehøjvej 2-year grass-clover field during 2001 and 2002.

This increase in respiration is linked to an increase in DOC content in the soil, figure 19. Additionally, the soil NO₃ content increases considerably (not shown). Thus, the denitrification is increased by the raise in microbial activity after autumn ploughing which increase the DOC and NO₃ in the soil.

Figure 20 compares the effect of spring ploughing in relation to the autumn ploughing on denitrification and N leaching. For the Burrehøjvej field the denitrification is increased slightly more by spring ploughing than by autumn ploughing the following year. This increase in denitrification is most apparent for short durations of grass-clover, figure 20, and without catch crops (not shown). After incorporation of plant residues, the microbial respiration increases as well as the DOC content in the soil, figure 19. Hence, spring and autumn ploughing of grass-clover promotes an increase in the microbial activity, DOC, and NO₃ content in the Burrehøjvej field and thereby the denitrification is increased.

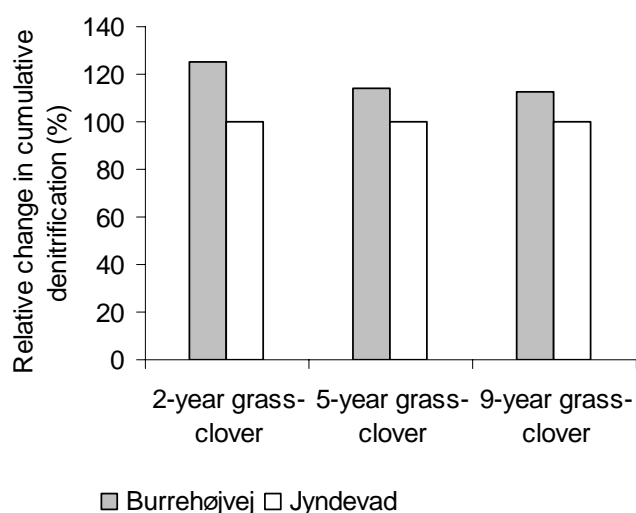

Figure 20. Effect of spring ploughing on denitrification from the two soils (0-200 cm) during 2002-2003. Relative change in cumulative denitrification compared with autumn ploughing.

N-leaching

According to figure 17 autumn ploughing increase the N-leaching the following year in relation to no ploughing. Additionally, the duration of grass-clover affects the amount of N-leaching after autumn ploughing by increasing N-leaching with increase in duration of grass-clover.

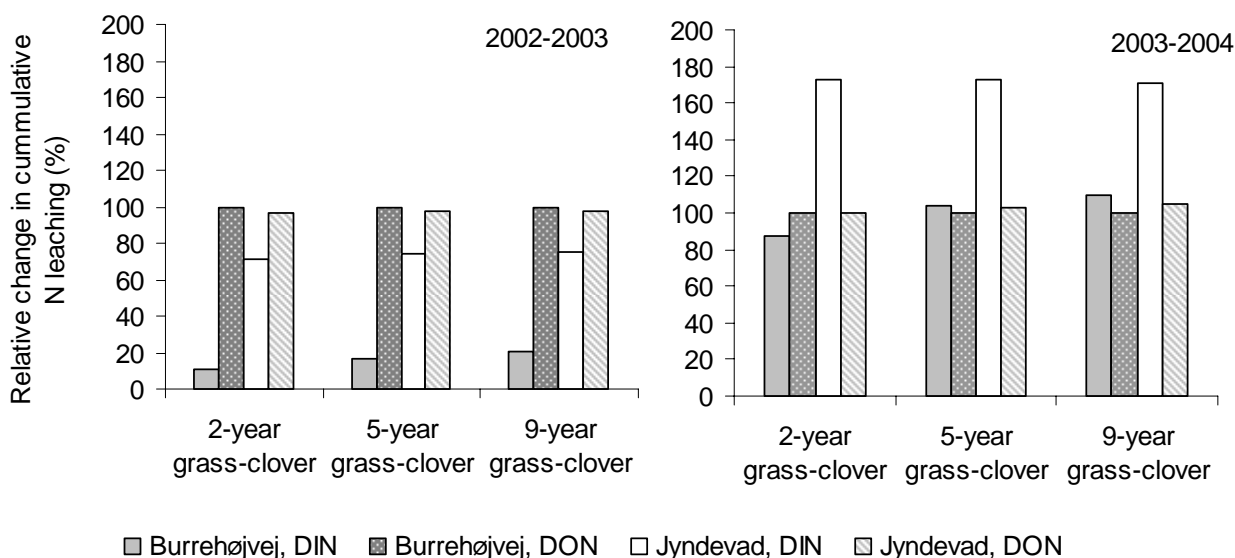

Figure 21. Effect of spring ploughing on DIN and DON leaching for the following year (left) and the second year (right) for the two soils (0-200 cm). Relative change in cumulative N leaching compared with autumn ploughing.

Figure 21 shows the effects of spring ploughing in relation to autumn ploughing on N-leaching for the following year (left) and the second year (right). Spring ploughing reduces total N-leaching considerably in relation to autumn ploughing the following year which is due to decrease in DIN leaching. For the Burrehøjvej field the leaching of DIN is reduced to 11-20 % of DIN-leached during autumn ploughing which corresponds to a reduction of 6-7 kg DIN ha⁻¹ year⁻¹. For the Jyndeved field the leaching of DIN is reduced by spring ploughing to 71-75 % of the DIN-leached during autumn ploughing which corresponds to a reduction of 20-22 kg DIN ha⁻¹ year⁻¹.

During the second year after spring ploughing, this corresponds to April 2003 - April 2004, spring ploughing increase total N-leaching considerably for the Jyndeved field. For the Burrehøjvej field total N-leaching is decreased for the short durations of grass-clover and increased for the long durations of grass-clover, figure 21. The change in N-leaching is due to change in DIN leaching as DON leaching is almost steady.

The cumulative effect of spring ploughing in relation to autumn ploughing on total N-leaching is shown in figure 22. For the Burrehøjvej field spring ploughing reduce N-leaching in relation to autumn ploughing. On the contrary spring ploughing increase N-leaching in relation to autumn ploughing for the Jyndeved soil. For both Jyndeved and Burrehøjvej field catch crops prevent leaching by crop uptake.

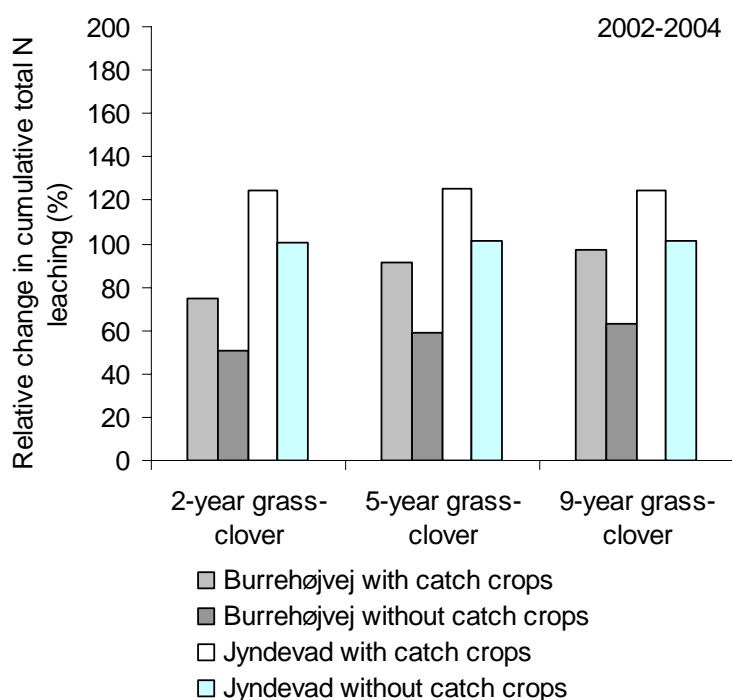

Figure 22. The cumulative effect of spring ploughing on total N-leaching for the two soils (0-200 cm). Relative change in cumulative total N leaching compared with autumn ploughing.

Generally, ploughing increase N-leaching for both soils. However, the time of soil ploughing have different effects on the N-leaching depending on the soil. For the sandy soil autumn ploughing is most sufficient in preventing N-leaching. For the sandy loam soil the spring ploughing is most feasible. The increase in N-leaching by ploughing is due to increase in DIN-leaching. DON leaching is not affected by soil ploughing.

2.2.3 Effect of catch crops

Denitrification

The effect of catch crops on denitrification and N-leaching at the two fields is shown in figure 23. Introducing catch crops to the field do not change the denitrification for the Jyndeved field and the denitrification is still negligible. For the Burrehøjvej field the catch crops increase the denitrification level by 21-25 % in relation to fields without catch crops. Apparently, the denitrification increase relative more for the short durations of grass-clover than for long durations. The increase in denitrification by introducing catch crops to the field is due to 18 % increase in microbial respiration which is due to root exudes and larger input of plant residues with catch crops to the soil.

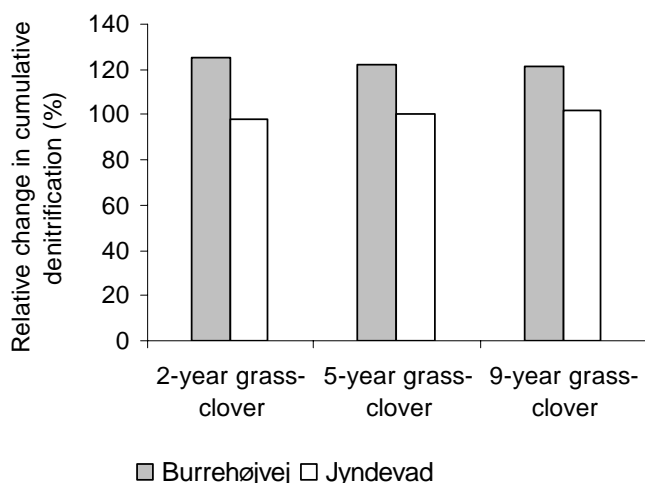

Figure 23. Effect of catch crops on denitrification from the two soils (0-200 cm) during 2003-2004. Relative change of cumulative denitrification compared with no catch crops.

N-leaching

The effect on catch crops on DIN and DON at the two fields is shown in figure 24. Introducing catch crops to the field reduce the DIN-leaching by 40-50 % for the Burrehøjvej field and 16-17 % for the Jyndeved field, figure 23. This reduction is due to increase in crop N uptake which remove NO_3 from the soil solution and prevent leaching. DON leaching is not affected by catch crops.

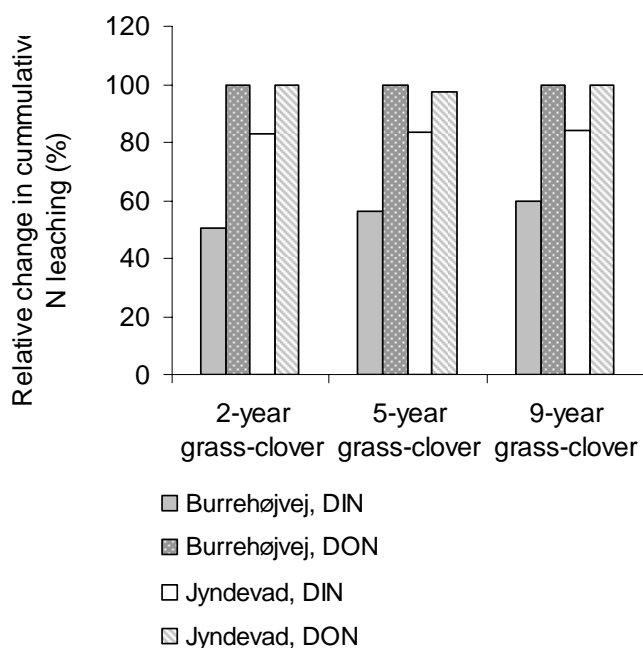

Figure 24. Effect of catch crops on DIN and DON leaching from the two soils (0-200 cm) during 2003-2004. Relative change in cumulative N leaching compared with no catch crops.

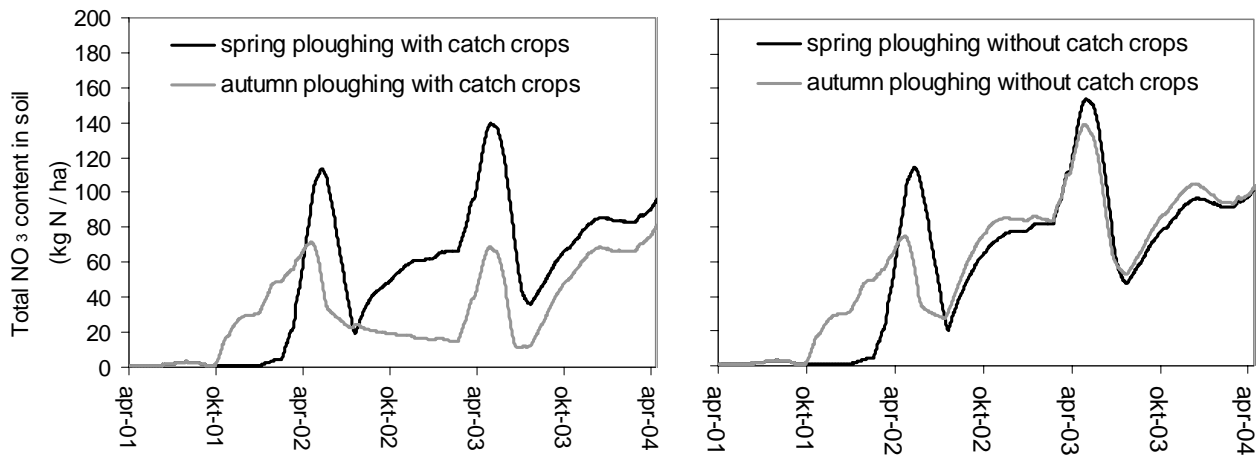

Figure 25. Effects of catch crops on the soil NO_3 content with time in the 2-year grass-clover Burrehøjvej field (0-200 cm).

Figure 25 shows the soil NO_3 content with time in the Burrehøjvej field soil. During October 2001 where the autumn ploughing occurs and Marts 2002 where the spring ploughing occurs, soil NO_3 content increase until the crops start to grow. Difference between spring and autumn ploughing on the NO_3 content is due to autumn sown catch crops are at a later development stage and take up more NO_3 than spring sown catch crops. After harvest in August 2002 the catch crops continue to grow and immobilize soil NO_3 reducing the N-leaching.

2.3 Conclusion

2.3.1 Denitrification

- Generally, the saturation degree of Jyndevad field is too small, limiting the denitrification process to a negligible level for all simulations performed. Only the Burrehøjvej field is contributing to the issue of denitrification.
- Denitrification increases with increase in duration of grass-clover. This increase in denitrification is correlated with an increase in microbial activity, DOC and NO₃ content in the soil.
- Spring and autumn ploughing of grass-clover promotes an increase in the microbial activity, DOC, and NO₃ content. The denitrification is increased slightly more by spring ploughing than by autumn ploughing.
- If catch crops are undersown the amount of NO₃ present in the soil is reduced due to crop uptake and denitrification is limited.

2.3.2 N-leaching

- Duration of grass-clover at the field does not affect the magnitude of DIN-leaching when no ploughing occurs but the DON leaching is increased slightly with increase in duration. Only the crop uptake increases systematically with increase in duration of grass-clover. This affects the N fixation which is reduced when the crop N-uptake increase.
- When the field is ploughed after continuous grass-clover, the duration of grass-clover affects the amount of DIN-leaching. Hence, increasing durations of grass-clover increase the N-leaching after soil ploughing.
- Generally, ploughing increase DIN-leaching for both soils. However, the time of soil ploughing have different effects on the N-leaching depending on the soil. For the sandy soil autumn ploughing is most reasonable in preventing N-leaching. For the sandy loam soil spring ploughing is most reasonable.
- Undersown catch crops reduce the DIN-leaching heavily which is due to increase in crop N uptake.

3 Reference List

- Abrahamsen,P. and Hansen,S., 2000. Daisy: an open soil-crop-atmosphere system model. *Environmental Modelling & Software*, 15(3): 313-330.
- Amato,M. and Ladd,J.N., 1992. Decomposition of C-14-Labeled Glucose and Legume Material in Soils - Properties Influencing the Accumulation of Organic Residue-C and Microbial Biomass-C. *Soil Biology & Biochemistry*, 24(5): 455-464.
- Burke,I.C., Yonker,C.M., Parton,W.J., Cole,C.V., Flach,K. and Schimel,D.S., 1989. Texture, climate, and cultivation effects on soil organic-matter content in us grassland soils. *Soil Science Society of America Journal*, 53(3): 800-805.
- Eriksen,J., 2001. Nitrate leaching and growth of cereal crops following cultivation of contrasting temporary grasslands. *Journal of Agricultural Science*, 136: 271-281.
- Eriksen,J., Vinther,F.P. and Søgaard,K., 2004. Nitrate leaching and N₂ fixation in grasslands of different composition, age and management. *Journal of Agricultural Science*, 142: 141-151.
- Gjettermann, B., Styczen, M., Hansen, S., Borggaard, O.K., Hansen, H.C.B. 2004. Sorption of dissolved organic C and P to agricultural top- and subsoil. ATV Møde. Vintermøde om Jord og Grundvandsforurening. Vingstedcentret 9.-10. Marts 2004.
- Gjettermann,B., Styczen,M., Hansen,S., Borggaard,O.K. and Hansen,H.C.B., 2005. Fractionation of dissolved organic C and P during sorption to agricultural soil. *European Journal of Soil Science*. In preparation.
- Greenland,D.J., 1971. Interactions between humic and fulvic acids and clays. *Soil Science*, 111(1): 34-&.
- Guggenberger,G. and Kaiser,K., 2003. Dissolved organic matter in soil: challenging the paradigm of sorptive preservation. *Geoderma*, 113(3-4): 293-310.
- Guggenberger,G. and Zech,W., 1992. Retention of dissolved organic-carbon and sulfate in aggregated acid forest soils. *Journal of Environmental Quality*, 21(4): 643-653.
- Hagedorn,F., Saurer,M. and Blaser,P., 2004. A C-13 tracer study to identify the origin of dissolved organic carbon in forested mineral soils. *European Journal of Soil Science*, 55(1): 91-100.
- Hansen,S., Jensen,H.E., Nielsen,N.E. and Svendsen,H., 1990. DAISY - Soil Plant Atmosphere System Model. In: Miljøministeriet Miljøstyrelsen, The Royal Veterinary and Agricultural University.
- Hansen,J.P. and Vinther,F.P., 2001. Spatial variability of symbiotic N₂ fixation in grass-white clover pastures estimated by the N-15 isotope dilution method and the natural N-15 abundance method. *Plant and Soil*, 230(2): 257-266.
- Hassink,J., 1997. The capacity of soils to preserve organic C and N by their association with clay and silt particles. *Plant and Soil*, 191(1): 77-87.
- Hinedi,Z.R., Chang,A.C. and Borchardt,D.B., 1997. Probing the association of fluorobenzene with dissolved organic matter using NMR spectroscopy. *Water Research*, 31(4): 877-883.

- Insam, H., 1996. Microorganisms and Humus in Soils. In: A. Piccolo (Editor), *Humic Substances in Terrestrial Ecosystems*. Elsevier Science B.V., pp. 265-292.
- Iversen, B.V., 2004. Soil Hydraulic Properties of Burrehøjvej field soil. Danish Institute of Agricultural Sciences. Department of Agroecology. Research Centre Foulum. Personal communication.
- Jacobsen, O.H., 1989. Umættet hydraulisk ledningsevne i nogle danske jorde. Beretning nr. S 2030 - 1989. Statens Planteavlsvforsøg.
- Jensen, L.S., Mueller, T., Bruun, S. and Hansen, S., 2001. Application of the DAISY model for short- and long-term simulation of soil carbon and nitrogen dynamics. In: M.J. Shaffer, L. Ma, and S. Hansen (Editors), *Modeling Carbon and Nitrogen Dynamics for Soil Management*. Lewis Publishers, Boca Raton, Florida, pp. 483-509.
- Kaiser, K., 2001. Dissolved organic phosphorus and sulphur as influenced by sorptive interactions with mineral subsoil horizons. *European Journal of Soil Science*, 52(3): 489-493.
- Kaiser, K., Guggenberger, G. and Zech, W., 1996. Sorption of DOM and DOM fractions to forest soils. *Geoderma*, 74(3-4): 281-303.
- Kaiser, K. and Zech, W., 2000. Sorption of dissolved organic nitrogen by acid subsoil horizons and individual mineral phases. *European Journal of Soil Science*, 51(3): 403-411.
- Kalbitz, K., Solinger, S., Park, J.H., Michalzik, B. and Matzner, E., 2000. Controls on the dynamics of dissolved organic matter in soils: A review. *Soil Science*, 165(4): 277-304.
- Lindhardt, B., Abildtrup, C., Vosgerau, H., Olsen, P., Torp, S., Iversen, B.V., Jørgensen, J.O., Plauborg, F., Rasmussen, P. and Gravesen, P., 2001. The Danish pesticide leaching assessment programme. Site characterization and monitoring design. Danmarks og Grønlands Geologiske Undersøgelse. ISBN 87-7871-094-4. 73 pp.
- McDowell, W.H. and Wood, T., 1984. Podsolization: Soil Processes control dissolved organic Carbon concentrations in stream water. *Soil Science*, 137(1): 23-32.
- Moore, T.R., 1989. Dynamics of Dissolved Organic-Carbon in Forested and Disturbed Catchments, Westland, New-Zealand .1. Maimai. *Water Resources Research*, 25(6): 1321-1330.
- Moore, T.R., Desouza, W. and Koprivnjak, J.F., 1992. Controls on the sorption of dissolved organic-carbon by soils. *Soil Science*, 154(2): 120-129.
- Neff, J.C. and Asner, G.P., 2001. Dissolved organic carbon in terrestrial ecosystems: Synthesis and a model. *Ecosystems*, 4(1): 29-48.
- Nodvin, S.C., Driscoll, C.T. and Likens, G.E., 1986. Simple partitioning of anions and dissolved organic-carbon in a forest soil. *Soil Science*, 142(1): 27-35.
- Pedersen, A., 2003. Setup of grass-clover and grazing cows in Daisy. The Royal Veterinary and Agricultural University. Department of Soil Science. Personal communication.
- Qualls, R.G. and Haines, B.L., 1992. Biodegradability of dissolved organic-matter in forest throughfall, soil solution, and stream water. *Soil Science Society of America Journal*, 56(2): 578-586.

- Qualls,R.G., Haines,B.L. and Swank,W.T., 1991. Fluxes of dissolved organic nutrients and humic substances in a deciduous forest. *Ecology*, 72(1): 254-266.
- Soil Survey Staff, 1999. *Keys to Soil Taxonomy*. Pocahontas Press, Blacksburg VI.
- Sollins,P., Homann,P. and Caldwell,B.A., 1996. Stabilization and destabilization of soil organic matter: Mechanisms and controls. *Geoderma*, 74(1-2): 65-105.
- Stevenson,F.J., 1994. *Humus chemistry: genesis, composition, reactions*. John Wiley, New York.
- Søegaard,K., Lund,P., Vinther,F.P., Petersen,S.O. and Aaes,O., 2001. Afgræsning med malkekøer. Betydningen af kløveriblanding, BPV- AAT-niveau i kraftfoder, slæt/afgræsning, ammoniakfordampning og N2 fiksering for udbytter og N-balancer. DJF rapport. Markbrug Nr. 51.
- Tegen,I. and Dorr,H., 1996. C-14 measurements of soil organic matter, soil CO₂ and dissolved organic carbon (1987-1992). *Radiocarbon*, 38(2): 247-251.
- Tipping,E., 1998. Modelling the properties and behaviour of dissolved organic matter in soils. *Mitteilgn. Dtsch. Bondenk. Gesellsch*, 87: 237-252.
- Tipping,E., Woof,C., Rigg,E., Harrison,A.F., Ineson,P., Taylor,K., Benham,D., Poskitt,J., Rowland,A.P., Bol,R. and Harkness,D.D., 1999. Climatic influences on the leaching of dissolved organic matter from upland UK Moorland soils, investigated by a field manipulation experiment. *Environment International*, 25(1): 83-95.
- Trumbore,S.E., Schiff,S.L., Aravena,R. and Elgood,R., 1992. Sources and Transformation of Dissolved Organic-Carbon in the Harp Lake Forested Catchment - the Role of Soils. *Radiocarbon*, 34(3): 626-635.
- Vance,G.F. and David,M.B., 1992. Dissolved organic-carbon and sulfate sorption by spodosol mineral horizons. *Soil Science*, 154(2): 136-144.
- Vinther, F. P., Hansen, E. M. and Eriksen, J., 2005. Leaching of soil organic carbon and nitrogen in a coarse sandy soil after cultivating grass-clover pastures. *J. Plant Nutr. Soil Sci.* (submitted).
- Vinther,F.P., Hansen,E.M. and Eriksen,J., 2005b. Udvaskning af organisk kulstof efter kløvergræs. In: J.E.Olesen (Editor), *Kulstoflagring og drivhusgasser fra jordbruget - potentiale og reduktionsmuligheder*. DJF rapport. In press.
- Vinther, F.P. & Hansen, S., 2004. SimDen - En simpel model til kvantificering af N₂O-emission og denitrifikation. DJF-rapport - Markbrug 104, 47 pp.
- Zech,W., Senesi,N., Guggenberger,G., Kaiser,K., Lehmann,J., Miano,T.M., Miltner,A. and Schroth,G., 1997. Factors controlling humification and mineralization of soil organic matter in the tropics. *Geoderma*, 79(1-4): 117-161.
- Zsolnay,A., 1996. Dissolved humus in soil waters. In: A.Piccilo (Editor), *Humic substances in terrestrial ecosystems*. Elsevier Science B.V., pp. 171-223.
- Zsolnay,A. and Steindl,H., 1991. Geovariability and biodegradability of the water-extractable organic material in an agricultural soil. *Soil Biology & Biochemistry*, 23(11): 1077-1082.

Appendix 1. Daisy setup for DOM calibration

Definitions of the horizons and the soil column of Burrehøjvej field

```
:: Soil texture
(defhorizon Ap_1 ISSS4 ; 0-20 cm
  (clay 6.8 [%])
  (silt 12.7 [%])
  (humus 5.190 [%])
  (fine_sand 55.4 [%])
  (coarse_sand 25.1 [%])
  (C_per_N 15.0)
  (hydraulic M_vG
    (K_sat 15.06945052) ;Hydraulic data from Bo Vangsø Iversen, økovand
    (Theta_res 0.05)
    (Theta_sat 0.572753)
    (alpha 0.031765)
    (n 1.306735))
  (attributes (Fe_d 79.97 [mmole/kg])
    (Al_ox 110.86 [mmole/kg])))

(defhorizon Ap_2 ISSS4 ; 20-30 cm
  (clay 6.8 [%])
  (silt 12.7 [%])
  (humus 5.190 [%])
  (fine_sand 55.4 [%])
  (coarse_sand 25.1 [%])
  (C_per_N 15.0)
  (hydraulic M_vG
    (K_sat 4.951531458) ;Hydraulic data from Bo Vangsø Iversen, økovand
    (Theta_res 0.05)
    (Theta_sat 0.42537)
    (alpha 0.042875)
    (n 1.306635))
  (attributes (Fe_d 79.97 [mmole/kg])
    (Al_ox 110.86 [mmole/kg])))

(defhorizon E_1_1 ISSS4 ; 30-40 cm
  (clay 12.6 [%])
  (silt 11.4 [%])
  (humus 0.2430 [%])
  (fine_sand 52.4 [%])
  (coarse_sand 23.6 [%])
  (C_per_N 15.1)
  (hydraulic M_vG
    (K_sat 4.951531458) ;Hydraulic data from Bo Vangsø Iversen, økovand
    (Theta_res 0.05)
    (Theta_sat 0.42537)
    (alpha 0.042875)
    (n 1.306635))
  (attributes (Fe_d 77.31 [mmole/kg])
    (Al_ox 81.26 [mmole/kg])))

(defhorizon E_1_2 ISSS4 ; 40-50 cm
  (clay 12.6 [%])
  (silt 11.4 [%])
  (humus 0.2430 [%])
  (fine_sand 52.4 [%])
  (coarse_sand 23.6 [%])
  (C_per_N 15.1)
  (hydraulic M_vG
    (K_sat 4.666315729) ;Hydraulic data from Bo Vangsø Iversen, økovand
```

```

        (Theta_res 0.05)
        (Theta_sat 0.351148)
        (alpha 0.02224)
        (n 1.532978)
(attributes (Fe_d 77.31 [mmole/kg]
            (Al_ox 81.26 [mmole/kg])))

(defhorizon E_2 ISSS4 ; 50-70 cm
(clay 12.6 [%])
(silt 11.4 [%])
(humus 0.2430 [%])
(fine_sand 52.4 [%])
(coarse_sand 23.6 [%])
(C_per_N 15.1)
(hydraulic M_vG
    (K_sat 4.666315729) ;Hydraulic data from Bo Vangsø Iversen, økovand
    (Theta_res 0.05)
    (Theta_sat 0.351148)
    (alpha 0.02224)
    (n 1.532978))
(attributes (Fe_d 77.31 [mmole/kg]
            (Al_ox 81.26 [mmole/kg])))

(defhorizon B ISSS4 ; 70-130 cm
(clay 14.8 [%])
(silt 9.7 [%])
(humus 0.1530 [%])
(fine_sand 54.4 [%])
(coarse_sand 21.1 [%])
(C_per_N 13.7)
(dry_bulk_density 1.82); dry_bulk_density from Anders Pedersen: "JB-Burrehoj.dat" og DJFrapport nr. 46 2001 ??)
(hydraulic hypres)
(attributes (Fe_d 83.00 [mmole/kg]
            (Al_ox 62.17 [mmole/kg])))

(defhorizon C ISSS4 ; 130-200 cm (130-140 data)
(clay 14.8 [%])
(silt 9.7 [%])
(humus 0.1470 [%])
(fine_sand 54.4 [%])
(coarse_sand 21.1 [%])
(C_per_N 13.7)
(dry_bulk_density 1.85); dry_bulk_density from Anders Pedersen: "JB-Burrehoj.dat" og DJFrapport nr. 46 2001 ??)
(hydraulic hypres)
(attributes (Fe_d 83.00 [mmole/kg]
            (Al_ox 62.17 [mmole/kg])))

;; .....
;; We use this column.

(defcolumn Burh default
(Bioclimate default(pet makkink))
(Groundwater file "E:/Mine Dokumenter/Daisy/BGJ settings/groundwater_burrehøj.gwt")
(Soil (horizons (-20 Ap_1)(-30 Ap_2)(-40 E_1_1)(-50 E_1_2)(-70 E_2)(-130 B)(-200 C))
    (zplus -5 -10 -15 -20
        -25 -30
        -40
        -50
        -60 -70
        -80 -90 -100 -110 -120 -130
        -140 -150 -160 -170 -180 -190 -200)
(MaxRootingDepth 95)); standardisering JB4 = 85, JB5 og JB6 = 100

(SoilWater (UZtop richards))

```



```

(SoilNH4 (transport cd))
(SoilNO3 (transport cd))
(OrganicMatter
  (active_underground true) ; Decomposition, mineralization and demineralisation below the root zone turned on
  (active_groundwater true) ; Decomposition, mineralization and demineralisation below the groundwater turned on
  (Bioincorporation)
  (smb ((fractions 0 0.6 0 0.35 0 0.05)) ; smb1, smb2, som1, som2, som3, dom
    ((fractions 0 0.35 0 0.6 0 0.05)))
  (som ((fractions 1 0 0 0 0 0))
    ((fractions 0.65 0 0.3 0 0 0.05))
    ((fractions 0 0 0 0 1 0)))
  (dom ((C (M 0.0 [g/cm^3])) ;;Definition of DOM
    (N (M 0.0 [g/cm^3]))
    (adsorption none) ;; ingen adsorption endnu
    (diffusion_coefficient 6.75e-6 [cm^2/s]) ; Hined et al., 1997.
    (efficiency 0.0 0.5) ;; Udnyttelsesgraden af dom1 af hhv smb1 og smb2 puljerne
    (fractions 0.0 1.0) ;; Incorporering af dom1 til hhv smb1 og smb2
    (turnover_rate 0.15e-3) ;; per hour!
    (transport cd)))
  (domsorp BGJ)
  (K_NH4 0.0208333)
  (K_NO3 0.0208333))

```

Definition of crops, tillage and manure

```

;Crops
(defcrop "RyeGrass DF_BGJ" Ryegrass) ;Søren Greve Olesens parameterization
(defcrop "WClover DF_BGJ" Wclover) ;Søren Greve Olesens parameterization
(defcrop "WClover DF_BGJ_2" Wclover) ;Søren Greve Olesens parameterization
(defcrop "WClover DF_BGJ_3" Wclover) ;Søren Greve Olesens parameterization
(defcrop "Spring Barley DF_BGJ" "Spring Barley")
(defcrop "Spring Wheat DF_BGJ" "Spring Wheat")

```

```

;Rotavation Burrehøj
(defaction rotavation7 mix -7.0
  (penetration 1.0))

```

```

;Plowing Burrehøj
(defaction plowing25 swap
  (middle -12.0)
  (depth -24.0))

```

```

;Seed bed preparation Burrehøj
(defaction seed_bed_preparation10 mix -10.0)

```

Deposition of manure by grazing cattle

```

(defaction Fer_Clover94 activity
  (fertilize
    (biomod_slurry_freshDF (weight 0.3311));= 233 kg N/ha jf. Søegaard Table 4 page 84
    (from 0.0) (to -19.0))
  (wait_days 1));dage imellem Fertilizer

```

```

(defaction Fer_Clover95 activity
  (fertilize
    (biomod_slurry_freshDF (weight 0.4362));= 307 kg N/ha jf. Søegaard
    (from 0.0) (to -19.0) )
  (wait_days 1) ;

```

```

(defaction Fer_Clover96 activity
  (fertilize
    (biomod_slurry_freshDF (weight 0.4376));= 308 kg N/ha jf. Søegaard

```

(from 0.0) (to -19.0))
(wait_days 1))

(defaction Fer_Clover_average activity
(fertilize
(biomod_slurry_freshDF (weight 0.4016));= 283 kg N/ha = average 1994-1996
(from 0.0) (to -19.0))
(wait_days 1))

Cutting grass-clover by grazing cattle

; Setup inspired by Anders Pedersen, KVL

(defaction Grass_GrazingDF activity
(wait (or(crop_ds_after "RyeGrass DF_BGJ" 0.7) (crop_dm_over "RyeGrass DF_BGJ" 1000 [kg DM/ha])))
(harvest "RyeGrass DF_BGJ"
(leaf 0.80) ;Leaf removes 80 %
(sorg 0.80) ;Storage organ 80 %
(stem 0.80) ;stem 80 %
(stub 5)) ;5 cm stub left at the field
(wait_days 5)) ;Five days between cuts

(defaction Clover_GrazingDF activity
(wait (or(crop_ds_after "WClover DF_BGJ" 0.7) (crop_dm_over "WClover DF_BGJ" 1000 [kg DM/ha])))
(harvest "WClover DF_BGJ" (leaf 0.80) (sorg 0.80) (stem 0.80) (stub 5))
(wait_days 10))

(defaction Clover_GrazingDF_2 activity
(wait (or(crop_ds_after "WClover DF_BGJ_2" 0.7)(crop_dm_over "WClover DF_BGJ_2" 1000 [kg DM/ha])))
(harvest "WClover DF_BGJ_2" (leaf 0.80) (sorg 0.80) (stem 0.80) (stub 5))
(wait_days 10))

(defaction Clover_GrazingDF_3 activity
(wait (or(crop_ds_after "WClover DF_BGJ_3" 0.7) (crop_dm_over "WClover DF_BGJ_3" 1000 [kg DM/ha])))
(harvest "WClover DF_BGJ_3" (leaf 0.80) (sorg 0.80) (stem 0.80) (stub 5))
(wait_days 10))

Management for 1-year ploughed

(defaction 1_year_ploughed activity

(wait_mm_dd 4 01) ;1 april 1993
(rotavation7)
(wait_mm_dd 4 11)
(plowing25)
(wait_mm_dd 04 14)
(seed_bed_preparation10)
(wait_mm_dd 04 20)
(sow "Spring Barley DF_BGJ")
(wait_mm_dd 04 21)
(progn (sow "RyeGrass DF_BGJ")(sow "WClover DF_BGJ") (sow "WClover DF_BGJ_2") (sow "WClover DF_BGJ_3"))
(wait_mm_dd 05 01)
(fertilize (N25S (weight 120.0)))

; Barley mature latest 25 August 1993 and harvested

(wait (or (crop_ds_after "Spring Barley DF_BGJ" 2.0) (mm_dd 8 25)))
(harvest "Spring Barley DF_BGJ" (leaf 1.0)(sorg 1.0) (stub 6.0) (stem 1.0))
(wait_days 1)
(harvest "RyeGrass DF_BGJ" (leaf 1.0)(sorg 1.0) (stub 6.0) (stem 1.0))
(harvest "WClover DF_BGJ" (leaf 1.0)(sorg 1.0) (stub 6.0) (stem 1.0))
(harvest "WClover DF_BGJ_2" (leaf 1.0)(sorg 1.0) (stub 6.0) (stem 1.0))
(harvest "WClover DF_BGJ_3" (leaf 1.0)(sorg 1.0) (stub 6.0) (stem 1.0))

(wait_mm_dd 05 05) ;5 May 1994 grazing begins until 13 October.
 (while (while (wait_mm_dd 10 13)
 (repeat Fer_Clover94) (repeat Grass_GrazingDF) (repeat Clover_GrazingDF_2)
 (wait_days 3)
 (repeat Clover_GrazingDF)
 (wait_days 3)
 (repeat Clover_GrazingDF_3)))

(wait_mm_dd 05 05) ;5 May 1995 grazing begins until 13 October.
 (while (while (wait_mm_dd 10 13)
 (repeat Fer_Clover95) (repeat Grass_GrazingDF) (repeat Clover_GrazingDF_2)
 (wait_days 3)
 (repeat Clover_GrazingDF)
 (wait_days 3)
 (repeat Clover_GrazingDF_3)))

(wait_mm_dd 05 05) ;5 May 1996 grazing begins until 13 October.
 (while (while (wait_mm_dd 10 13)
 (repeat Fer_Clover96) (repeat Grass_GrazingDF) (repeat Clover_GrazingDF_2)
 (wait_days 3)
 (repeat Clover_GrazingDF)
 (wait_days 3)
 (repeat Clover_GrazingDF_3)))

(wait_mm_dd 4 01);1 April 1997
 (rotavation7)
 (wait_mm_dd 4 11)
 (plowing25)
 (wait_mm_dd 04 14)
 (seed_bed_preparation10)
 (wait_mm_dd 04 15)
 (sow "Spring Barley DF_BGJ")
 (sow "RyeGrass DF_BGJ")
 (wait (or (crop_ds_after "Spring Barley DF_BGJ" 2.0) (mm_dd 8 25)))
 (harvest "Spring Barley DF_BGJ" (leaf 1.0)(sorg 1.0) (stub 6.0) (stem 1.0))
 (wait_days 1)
 (harvest "RyeGrass DF_BGJ" (leaf 1.0)(sorg 1.0) (stub 6.0) (stem 1.0))

(wait_mm_dd 4 01) ;1 April 1998
 (rotavation7)
 (wait_mm_dd 4 11)
 (plowing25)
 (wait_mm_dd 04 14)
 (seed_bed_preparation10)
 (wait_mm_dd 04 15)
 (sow "Spring Wheat DF_BGJ")
 (sow "RyeGrass DF_BGJ")
 (wait (or (crop_ds_after "Spring Wheat DF_BGJ" 2.0) (mm_dd 8 25)))
 (harvest "Spring Wheat DF_BGJ" (leaf 1.0)(sorg 1.0) (stub 6.0) (stem 1.0))
 (wait_days 1)
 (harvest "RyeGrass DF_BGJ" (leaf 1.0)(sorg 1.0) (stub 6.0) (stem 1.0))

(wait_mm_dd 4 01) ;1 April 1999
 (rotavation7)
 (wait_mm_dd 4 11)
 (plowing25)
 (wait_mm_dd 04 14)
 (seed_bed_preparation10)
 (wait_mm_dd 04 15)
 (sow "Spring Barley DF_BGJ")
 (sow "RyeGrass DF_BGJ")
 (wait (or (crop_ds_after "Spring Barley DF_BGJ" 2.0) (mm_dd 8 25)))
 (harvest "Spring Barley DF_BGJ" (leaf 1.0)(sorg 1.0) (stub 6.0) (stem 1.0))
 (wait_days 1)

```

(harvest "RyeGrass DF_BGJ" (leaf 1.0)(sorg 1.0) (stub 6.0) (stem 1.0))
(wait_mm_dd 4 01) ;1 April 2000
(rotavation7)
(wait_mm_dd 4 11)
(plowing25)
(wait_mm_dd 04 14)
(seed_bed_preparation10)
(wait_mm_dd 04 20)
(sow "Spring Barley DF_BGJ")
(wait_mm_dd 04 21)
(progn (sow "RyeGrass DF_BGJ" ) (sow "WClover DF_BGJ") (sow "WClover DF_BGJ_2") (sow "WClover DF_BGJ_3"))

(wait (or (crop_ds_after "Spring Barley DF_BGJ" 2.0)(mm_dd 8 25)))
(harvest "Spring Barley DF_BGJ" (leaf 1.0)(sorg 1.0) (stub 6.0) (stem 1.0))
(wait_days 1)
(harvest "RyeGrass DF_BGJ" (leaf 1.0)(sorg 1.0) (stub 6.0) (stem 1.0))
(harvest "WClover DF_BGJ" (leaf 1.0)(sorg 1.0) (stub 6.0) (stem 1.0))
(harvest "WClover DF_BGJ_2" (leaf 1.0)(sorg 1.0) (stub 6.0) (stem 1.0))
(harvest "WClover DF_BGJ_3" (leaf 1.0)(sorg 1.0) (stub 6.0) (stem 1.0))

(wait_mm_dd 05 05) ;5 Maj 2001 grazing begins until 13 october.
(while (while (wait_mm_dd 10 13)
(repeat Fer_Clover_average) (repeat Grass_GrazingDF) (repeat Clover_GrazingDF_2)
(wait_days 3)
(repeat Clover_GrazingDF)
(wait_days 3)
(repeat Clover_GrazingDF_3)
))
(wait_mm_dd 03 22);22 marts 2002
(rotavation7)
(wait_mm_dd 04 02)
(plowing25)
(wait_mm_dd 04 05)
(sow "Spring Wheat DF_BGJ")
(wait_mm_dd 04 06)
(sow "RyeGrass DF_BGJ" )
(wait_mm_dd 08 20)
(harvest "Spring Wheat DF_BGJ"(leaf 1.0)(sorg 1.0)(stub 5.0) (stem 1.0))
(wait_days 1)
(harvest "RyeGrass DF_BGJ" (leaf 1.0) (sorg 1.0) (stub 5.0) (stem 1.0))
)

;.....
;;Simulation start date:
(time 1993 01 01 01) ; 1993, 1. January

(manager activity One_year_ploughed
(wait (at 2003 04 30 0))
(stop))
;.....

```

Management for 8-year ploughed

(defaction Eight_year_ploughed activity

```

(wait_mm_dd 4 01); 1 April 1993
(rotavation7)
(wait_mm_dd 4 11)
(plowing25)
(wait_mm_dd 04 14)
(seed_bed_preparation10)
(wait_mm_dd 04 20)

```

```

(sow "Spring Barley DF_BGJ")
(wait_mm_dd 04 21)
(prong (sow "RyeGrass DF_BGJ" ) (sow "WClover DF_BGJ") (sow "WClover DF_BGJ_2")(sow "WClover DF_BGJ_3"))
(wait_mm_dd 05 01)
(fertilize (N25S (weight 120.0)))
(wait (or (crop_ds_after "Spring Barley DF_BGJ" 2.0) (mm_dd 8 25)))
(harvest "Spring Barley DF_BGJ" (leaf 1.0)(sorg 1.0)(stub 6.0) (stem 1.0))
(wait_days 1)
(harvest "RyeGrass DF_BGJ" (leaf 1.0)(sorg 1.0)(stub 6.0) (stem 1.0))
(harvest "WClover DF_BGJ" (leaf 1.0)(sorg 1.0)(stub 6.0) (stem 1.0))
(harvest "WClover DF_BGJ_2" (leaf 1.0)(sorg 1.0)(stub 6.0) (stem 1.0))
(harvest "WClover DF_BGJ_3" (leaf 1.0)(sorg 1.0)(stub 6.0) (stem 1.0))

(wait_mm_dd 05 05) ;5 May 1994
(while (while (wait_mm_dd 10 13)
(repeat Fer_Clover94) (repeat Grass_GrazingDF) (repeat Clover_GrazingDF_2)
(wait_days 3)
(repeat Clover_GrazingDF)
(wait_days 3)
(repeat Clover_GrazingDF_3)))

(wait_mm_dd 05 05) ;5 May 1995
(while (while (wait_mm_dd 10 13)
(repeat Fer_Clover95) (repeat Grass_GrazingDF) (repeat Clover_GrazingDF_2)
(wait_days 3)
(repeat Clover_GrazingDF)
(wait_days 3)
(repeat Clover_GrazingDF_3)))

(wait_mm_dd 05 05) ;5 May 1996
(while (while (wait_mm_dd 10 13)
(repeat Fer_Clover96) (repeat Grass_GrazingDF) (repeat Clover_GrazingDF_2)
(wait_days 3)
(repeat Clover_GrazingDF)
(wait_days 3)
(repeat Clover_GrazingDF_3)))

(wait_mm_dd 05 05) ;5 May 1997
(while (while (wait_mm_dd 10 13)
(repeat Fer_Clover_average) (repeat Grass_GrazingDF) (repeat Clover_GrazingDF_2)
(wait_days 3)
(repeat Clover_GrazingDF)
(wait_days 3)
(repeat Clover_GrazingDF_3)))

(wait_mm_dd 05 05) ;5 May 1998
(while (while (wait_mm_dd 10 13)
(repeat Fer_Clover_average) (repeat Grass_GrazingDF) (repeat Clover_GrazingDF_2)
(wait_days 3)
(repeat Clover_GrazingDF)
(wait_days 3)
(repeat Clover_GrazingDF_3)))

(wait_mm_dd 05 05) ; 5 maj 1999

```

```

(while (while (wait_mm_dd 10 13)
  (repeat Fer_Clover_average) (repeat Grass_GrazingDF) (repeat Clover_GrazingDF_2)
  (wait_days 3)
  (repeat Clover_GrazingDF)
  (wait_days 3)
  (repeat Clover_GrazingDF_3)))

(wait_mm_dd 05 05) ; 5 maj 2000
(while (while (wait_mm_dd 10 13)
  (repeat Fer_Clover_average) (repeat Grass_GrazingDF) (repeat Clover_GrazingDF_2)
  (wait_days 3)
  (repeat Clover_GrazingDF)
  (wait_days 3)
  (repeat Clover_GrazingDF_3)))

(wait_mm_dd 05 05) ; 5 may 2001
(while (while (wait_mm_dd 10 13)
  (repeat Fer_Clover_average) (repeat Grass_GrazingDF) (repeat Clover_GrazingDF_2)
  (wait_days 3)
  (repeat Clover_GrazingDF)
  (wait_days 3)
  (repeat Clover_GrazingDF_3)))

(wait_mm_dd 03 22) ; 22 Marts 2002
  (rotavation7)
(wait_mm_dd 04 02)
  (plowing25)
(wait_mm_dd 04 05)
  (sow "Spring Wheat DF_BGJ")
(wait_mm_dd 04 06)
  (sow "RyeGrass DF_BGJ" )
(wait_mm_dd 08 20)
  (harvest "Spring Wheat DF_BGJ"(leaf 1.0)(sorg 1.0)(stub 5.0)(stem 1.0))
(wait_days 1)
  (harvest "RyeGrass DF_BGJ" (leaf 1.0)(sorg 1.0)(stub 5.0)(stem 1.0))
)

```

:: Simulation start:

```

(time 1993 01 01 01)
(manager activity Eight_year_ploughed
  (wait (at 2003 04 30 0))
  (stop))

```

Management for 9-year grass-clover

```

(defaction Nine_year_grazing activity
  (wait_mm_dd 4 01); 1 April 1993
  (rotavation7)
  (wait_mm_dd 4 11)
  (plowing25)
  (wait_mm_dd 04 14)
  (seed_bed_preparation10)
  (wait_mm_dd 04 20)
  (sow "Spring Barley DF_BGJ")
  (wait_mm_dd 04 21)
)

```

```

(progn (sow "RyeGrass DF_BGJ" )(sow "WClover DF_BGJ" )(sow "WClover DF_BGJ_2" )(sow "WClover DF_BGJ_3" ))
(wait_mm_dd 05 01)
(fertilize (N25S (weight 120.0)))
(wait (or (crop_ds_after "Spring Barley DF_BGJ" 2.0)(mm_dd 8 25)))
(harvest "Spring Barley DF_BGJ" (leaf 1.0) (sorg 1.0) (stub 6.0) (stem 1.0))
(wait_days 1)
(harvest "RyeGrass DF_BGJ" (leaf 1.0) (sorg 1.0) (stub 6.0) (stem 1.0))
(harvest "WClover DF_BGJ" (leaf 1.0) (sorg 1.0) (stub 6.0) (stem 1.0))
(harvest "WClover DF_BGJ_2" (leaf 1.0) (sorg 1.0) (stub 6.0) (stem 1.0))
(harvest "WClover DF_BGJ_3" (leaf 1.0) (sorg 1.0) (stub 6.0) (stem 1.0))

```

```

(wait_mm_dd 05 05) ; 5 may 1994
(while (while (wait_mm_dd 10 13)
(repeat Fer_Clover94) (repeat Grass_GrazingDF) (repeat Clover_GrazingDF_2)
(wait_days 3)
(repeat Clover_GrazingDF)
(wait_days 3)
(repeat Clover_GrazingDF_3)))

```

```

(wait_mm_dd 05 05) ; 5 may 1995
(while (while (wait_mm_dd 10 13)
(repeat Fer_Clover95) (repeat Grass_GrazingDF) (repeat Clover_GrazingDF_2)
(wait_days 3)
(repeat Clover_GrazingDF)
(wait_days 3)
(repeat Clover_GrazingDF_3)))

```

```

(wait_mm_dd 05 05) ;5 may 1996
(while (while (wait_mm_dd 10 13)
(repeat Fer_Clover96) (repeat Grass_GrazingDF) (repeat Clover_GrazingDF_2)
(wait_days 3)
(repeat Clover_GrazingDF)
(wait_days 3)
(repeat Clover_GrazingDF_3)))

```

```

(wait_mm_dd 05 05) ;5 may 1997
(while (while (wait_mm_dd 10 13)
(repeat Fer_Clover_average) (repeat Grass_GrazingDF) (repeat Clover_GrazingDF_2)
(wait_days 3)
(repeat Clover_GrazingDF)
(wait_days 3)
(repeat Clover_GrazingDF_3)))

```

```

(wait_mm_dd 05 05) ; 5 may 1998
(while (while (wait_mm_dd 10 13)
(repeat Fer_Clover_average) (repeat Grass_GrazingDF) (repeat Clover_GrazingDF_2)
(wait_days 3)
(repeat Clover_GrazingDF)
(wait_days 3)
(repeat Clover_GrazingDF_3)))

```

```

(wait_mm_dd 05 05) ; 5 may 1999
(while (while (wait_mm_dd 10 13)
(repeat Fer_Clover_average) (repeat Grass_GrazingDF) (repeat Clover_GrazingDF_2)
(wait_days 3)
(repeat Clover_GrazingDF)
(wait_days 3)
(repeat Clover_GrazingDF_3)))

```

```

(wait_mm_dd 05 05) ; 5 may 2000
(while (while (wait_mm_dd 10 13)
(repeat Fer_Clover_average) (repeat Grass_GrazingDF) (repeat Clover_GrazingDF_2)
(wait_days 3)
(repeat Clover_GrazingDF)

```

```

(wait_days 3)
(repeat Clover_GrazingDF_3)))

(wait_mm_dd 05 05) ; 5 may 2001
(while (while (wait_mm_dd 10 13)
(repeat Fer_Clover_average) (repeat Grass_GrazingDF) (repeat Clover_GrazingDF_2)
(wait_days 3)
(repeat Clover_GrazingDF)
(wait_days 3)
(repeat Clover_GrazingDF_3)))

(wait_mm_dd 05 05) ; 5 may 2002
(while (while (wait_mm_dd 10 13)
(repeat Fer_Clover_average) (repeat Grass_GrazingDF) (repeat Clover_GrazingDF_2)
(wait_days 3)
(repeat Clover_GrazingDF)
(wait_days 3)
(repeat Clover_GrazingDF_3)))
)

;;Simulation start date:
(time 1993 01 01 01) ; 1993, september d. 1. kl.23.00.

(manager activity Nine_year_grazing
(wait (at 2003 04 30 0))
(stop))

```

Output

```

(activate_output (after 1994 01 1 0))
(output
("Daily Soil Content" (when daily)) ;; water, NH4, NO3, m.m. in each horizon
("N Balance" (when daily))
("Carbon Balance" (when daily))
("Soil N Residuals" (when hourly))
("Soil C Residuals" (when hourly))
("Crop C N" (when hourly))
("Crop C N daily" (when daily))
("Surface Water Balance" (when daily))
("Root Zone Water Balance" (when daily) (from -0 [cm])(to -200 [cm]))
("Soil Water Content") ;; Water content in all numeric nodes
("Soil water potential") ;; water potential in all numeric nodes.
("Matrix Water Flux") ;; water flux in all numeric nodes.
("NO3 Root Uptake" (when hourly))
("NH4 Root Uptake" (when hourly))
("Soil NO3") ;; NO3 content in all numeric nodes
("Soil NH4") ;; NH4 content in all numeric nodes
("Soil temperature" (when hourly)) ;; Temperature in all numeric nodes.
("Soil NO3 flux")
("Soil NH4 flux")
("DOM N flux")
("DOM C flux")
(harvest (where "harvest.dlf" ))

"Crop Production" ("Crop Production" (set "$crop" "WClover DF_BGJ")
(when daily)(where "Crop_Wclover.dlf"))
("Crop Production" (set "$crop" "WClover DF_BGJ_2")
(when daily)(where "Crop_Wclover_2.dlf"))
("Crop Production" (set "$crop" "WClover DF_BGJ_3")
(when daily)(where "Crop_Wclover_3.dlf"))
("Crop Production" (set "$crop" "RyeGrass DF_BGJ")
(when daily)(where "Crop_grass.dlf"))
("Crop Production" (set "$crop" "Spring Barley DF_BGJ")

```

(when daily)(where "Crop_barley.dlf")
("Crop Production"(set "\$crop" "Spring Wheat DF_BGJ")
(when daily)(where "Crop_wheat.dlf"))

("Harvest_N_C")
("Harvest_N_C daily")
("Organic Matter total" (when daily)) ;; Organic matter (C, N and P) in profile
("AOM Pools total" (when daily)) ;; Added organic matter (C, N and P) in profile
("DOM Pools total" (when daily)) ;; Dissolved organic matter (C, N and P) in profile
("Weather")
("Denit 30") ;Denitrification and DOM: Suction cups
("Denit 60")
("Denit 90")
("Denit 130")
("Denit total")

)

Appendix 2. Daisy setup for denitrification and N-leaching analysis

Definition of the Daisy setup of the Burrehøjvej field soil is given in Appendix 1.

Definition of the Jynde vad soil

```
(defhorizon Ap ISSS4 ; 0-25cm
;(C_per_N 12) ;Annex 2 Jynde vad Søren Torp, Foulum
(clay 3.6 [%]) ;<2um, Texture from Ole Hørby Jacobsen, 1989, lag 15 cm
(silt 4.7 [%]) ;2-20 um
(fine_sand 22 [%]) ;20-200 um
(coarse_sand 67.4 [%]) ;200-2000 um
(humus 2.3 [%])
(hydraulic M_vG
(K_sat 24.3 [cm/h]) ;Hydraulic data fitted to data from Ole Hørby Jacobsen, 1989
(Theta_res 0.061)
(Theta_sat 0.439)
(alpha 0.057 [cm^-1])
(n 1.754))
(attributes (Fe_d 55 [mmole/kg]) ; Fe_d = Fe_ox * 1.9 Data from søndersø catchment
(Al_ox 35 [mmole/kg]))) ;Annex 2 Jynde vad Søren Torp, Foulum

(defhorizon Bhs ISSS4 ; 25-50 cm
;(C_per_N 13)
(clay 3.5 [%]) ;<2um, Tekstur from Ole Hørby Jacobsen, 1989, lag 50 cm
(silt 1.9 [%]) ;2-20 um
(fine_sand 14.7 [%]) ;20-200 um
(coarse_sand 79.3 [%]) ;200-2000 um
(humus 0.6 [%])
(hydraulic M_vG
(K_sat 64.0 [cm/h]) ;Hydraulic data fitted to data from Ole Hørby Jacobsen, 1989
(Theta_res 0.042)
(Theta_sat 0.438)
(alpha 0.054 [cm^-1])
(n 2.416))
(attributes (Fe_d 43 [mmole/kg])
(Al_ox 72 [mmole/kg])))

(defhorizon Bs ISSS4 ; 50-85 cm
;(C_per_N 6)
(clay 2.6 [%]) ;<2um, Tekstur from Ole Hørby Jacobsen, 1989, lag 70 cm
(silt 1.4 [%]) ;2-20 um
(fine_sand 11.4 [%]) ;20-200 um
(coarse_sand 84.2 [%]) ;200-2000 um
(humus 0.4 [%])
(hydraulic M_vG
(K_sat 77.0 [cm/h]) ;Hydraulic data fitted to data from Ole Hørby Jacobsen, 1989
(Theta_res 0.028)
(Theta_sat 0.441)
(alpha 0.012 [cm^-1])
(n 3.469))
(attributes (Fe_d 28 [mmole/kg])
(Al_ox 53 [mmole/kg])))

(defhorizon BC_1 ISSS4 ; 85-95 cm
;(C_per_N 3)
(clay 2.6 [%]) ;<2um, Texture from Ole Hørby Jacobsen, 1989, 90 cm
(silt 0.5 [%]) ;2-20 um
(fine_sand 5.8 [%]) ;20-200 um
(coarse_sand 90.9 [%]) ;200-2000 um
```

```

(humus 0.2 [%])
(hydraulic M_vG
  (K_sat 92.5 [cm/h]) ; Hydraulic data fitted to data from Ole Hørby Jacobsen, 1989
  (Theta_res 0.030)
  (Theta_sat 0.418)
  (alpha 0.054 [cm^-1])
  (n 2.816))
(attributes (Fe_d 34 [mmole/kg])
  (Al_ox 37 [mmole/kg])))

(defhorizon BC_2 ISSS4 ; 95-115 cm
;(C_per_N 6)
(clay 2.6 [%]) ;<2um, Texture from Ole Hørby Jacobsen, 1989, lag 90 cm
(silt 0.5 [%]) ;2-20 um
(fine_sand 5.8 [%]) ;20-200 um
(coarse_sand 90.9 [%]) ;200-2000 um
(humus 0.2 [%])
(hydraulic M_vG
  (K_sat 92.5 [cm/h]) ; Hydraulic data fitted to data from Ole Hørby Jacobsen, 1989
  (Theta_res 0.030)
  (Theta_sat 0.418)
  (alpha 0.054 [cm^-1])
  (n 2.816))
(attributes (Fe_d 42 [mmole/kg])
  (Al_ox 47 [mmole/kg])))

(defhorizon C ISSS4 ; 115-200 cm
;(C_per_N 3)
(clay 2.6 [%]) ;<2um, Tekstur from Ole Hørby Jacobsen, 1989, lag 90 cm
(silt 0.5 [%]) ;2-20 um
(fine_sand 5.8 [%]) ;20-200 um
(coarse_sand 90.9 [%]) ;200-2000 um
(humus 0.2 [%])
(hydraulic M_vG
  (K_sat 92.5 [cm/h]) ; Hydraulic data fitted to data from Ole Hørby Jacobsen, 1989
  (Theta_res 0.030)
  (Theta_sat 0.418)
  (alpha 0.054 [cm^-1])
  (n 2.816))
(attributes (Fe_d 27 [mmole/kg])
  (Al_ox 24 [mmole/kg])))

;; We use this column.
(defcolumn Jynd default
  (Bioclimate default(pet makkink))
  (Groundwater file "E:/Mine Dokumenter/Daisy/BGJ settings/groundwater_jyndeivad.gwt")
  (Soil (horizons (-25 Ap)(-50 Bhs)(-85 Bs)(-95 BC_1)(-115 BC_2)(-200 C))
    (zplus -5 -10 -15 -20 -25
      -30 -40 -50
      -60 -70 -80
      -90
      -100 -110
      -120 -130 -140 -150 -160 -170 -180 -190 -200)
    (MaxRootingDepth 50))
  (SoilWater (UZtop richards))
  (SoilNH4 (transport cd))
  (SoilNO3 (transport cd))
  (OrganicMatter
    (active_underground true) ; Decomposition, mineralization and demineralisation below the root zone turned on
    (active_groundwater true) ; Decomposition, mineralization and demineralisation below the groundwater turned on
    (Bioincorporation)
    (smb ((fractions 0 0.6 0 0.35 0 0.05)) ; smb1, smb2, som1, som2, som3, dom
      ((fractions 0 0.35 0 0.6 0 0.05)))
    (som ((fractions 1 0 0 0 0)))

```

```

((fractions 0.65 0 0.3 0 0 0.05))
((fractions 0 0 0 0 1 0)))
(dom ((C (M 0.0 [g/cm^3])) ;;Definition of DOM
      (N (M 0.0 [g/cm^3]))
      (adsorption none) ;; ingen adsorption endnu
      (diffusion_coefficient 6.75e-6 [cm^2/s]) ; Hined et al., 1997.
      (efficiency 0.0 0.5) ;; Udnyttelsesgraden af dom1 af hhv smb1 og smb2 puljerne
      (fractions 0.0 1.0) ;; Incorporering af dom1 til hhv smb1 og smb2
      (turnover_rate 0.15e-3) ;; per hour!
      (transport cd)))
(domsorp BGJ)
(K_NH4 0.0208333)
(K_NO3 0.0208333))

```

Managements for the warm-up phase and the 2, 5 and 9 year of grass-clover

;; Plant production

```

(defaction "P_crop1" activity
  (wait_mm_dd 3 05) ;dk-management
  (fertilize ("slagtesvin_gylle" (first_year_utilization 1))(equivalent_weight 94 [kg N/ha])(to -1)) ;dk-management
  (plowing)
  (wait_mm_dd 4 05);dk-management
  (seed_bed_preparation)
  (sow "Vaarbyg")
  (wait_mm_dd 4 06)
  (sow "SGO_Wclover_1") (sow "SGO_Wclover_2") (sow "SGO_Wclover_3") (sow "SGO_Ryegrass")
  (wait (or (crop_ds_after "Vaarbyg" 2.0)(mm_dd 08 20))) ;dk-management
  (harvest "Vaarbyg" (stub 8 [cm])(stem 0.70)) ;dk-management
  (harvest "SGO_Ryegrass" (stub 8 [cm])(sorg 0.80)(stem 0.80)(leaf 0.80))
  (harvest "SGO_Wclover_1" (stub 8 [cm])(sorg 0.80)(stem 0.80)(leaf 0.80))
  (harvest "SGO_Wclover_2" (stub 8 [cm])(sorg 0.80)(stem 0.80)(leaf 0.80))
  (harvest "SGO_Wclover_3" (stub 8 [cm])(sorg 0.80)(stem 0.80)(leaf 0.80))
)
;-----
(defaction "P_crop2" activity
  (wait_mm_dd 05 05)
  (while (while (wait_mm_dd 10 02)
    (repeat Fertilise_grazing) (repeat Grass_Grazing) (repeat Clover1_Grazing)
    (wait_days 3)
    (repeat Clover2_Grazing)
    (wait_days 3)
    (repeat Clover3_Grazing)))
)
;-----
(defaction "P_crop3" activity
  (wait_mm_dd 3 05);dk-management
  (fertilize ("slagtesvin_gylle" (first_year_utilization 1)) (equivalent_weight 75 [kg N/ha]) (to -1)) ; dk-management
  (plowing)
  (wait_mm_dd 4 05) ; dk-management
  (seed_bed_preparation)
  (sow "Vaarbyg")
  (wait_mm_dd 4 06)
  (sow "SGO_Ryegrass")
  (wait (or (crop_ds_after "Vaarbyg" 2.0)(mm_dd 08 20))) ;dk-management
  (harvest "Vaarbyg" (stub 8 [cm])(stem 0.70)) ;dk-management
  (harvest "SGO_Ryegrass" (stub 8 [cm])(sorg 0.80)(stem 0.80)(leaf 0.80))
)
;-----
(defaction "P_crop4" activity
  (wait_mm_dd 3 05);økovand
  (fertilize ("slagtesvin_gylle" (first_year_utilization 1)) (equivalent_weight 94 [kg N/ha]) (to -1))

```

```

(plowing)
(wait_mm_dd 04 14)
(seed_bed_preparation)
(wait_mm_dd 04 15)
(sow "Spring Wheat") (sow "SGO_Ryegrass")
(wait (or (crop_ds_after "Spring Wheat" 2.0)(mm_dd 8 25)))
(harvest "Spring Wheat" (leaf 1.0) (sorg 1.0) (stub 6.0) (stem 1.0))
(harvest "SGO_Ryegrass"(leaf 1.0) (sorg 1.0) (stub 6.0) (stem 1.0))
)
;-----
;; Growing of Rye / Pea - the two crops are sown and harvested
;; simultaneously - inspired by dk-managemen.dai:
(defaction "P_crop5" activity
  (wait_mm_dd 3 05)
  (plowing)
  (wait_mm_dd 4 05)(seed_bed_preparation)
  (progn (sow "Rug")(sow "Aert"))
  (wait_mm_dd 7 05)
  (progn
    (harvest "Rug" (stub 8 [cm]))
    (harvest "Aert" (stub 8 [cm])))
  )
)
;-----
(defaction opvarmning activity
  (wait_mm_dd 1 01)
  P_crop1
  P_crop2
  P_crop3
  P_crop4
  P_crop5
  P_crop1
  P_crop2
  P_crop3
  P_crop4
  P_crop5
  )
)
;-----
; 9-year grazing

(defaction Nine_year_grazing activity
  P_crop1 ;1991
  P_crop2 ;5 maj 1992
  P_crop2 ;5 maj 1993
  P_crop2 ;5 maj 1994.
  P_crop2 ;5 maj 1995
  P_crop2 ;5 maj 1996
  P_crop2 ;5 maj 1997
  P_crop2 ;5 maj 1998
  P_crop2 ;5 maj 1999
  P_crop2 ;5 maj 2000
  )
)
;-----
; 5-year grazing

(defaction five_year_grazing activity
  P_crop1 ;1995
  P_crop2 ;5 maj 1996
  P_crop2 ;5 maj 1997
  P_crop2 ;5 maj 1998
  P_crop2 ;5 maj 1999
  P_crop2 ;5 maj 2000
  )
)
;-----
; 2-year grazing

```

```

(defaction two_year_grasing activity
  P_crop1      ;1995
  P_crop2      ;5 maj 1999
  P_crop2      ;5 maj 2000
)
;-----
; spring ploughing

(defaction spring_m_fangafg activity
  P_crop2      ;5 maj 2001
  ;;Vårbyg med rajgræs udlæg. 2002
  (wait_mm_dd 3 05) ;dk-management
  (fertilize ("slagtesvin_gylle" (first_year_utilization 1))
    (equivalent_weight 75 [kg N/ha])
    (to -1)) ;dk-management
  (plowing)
  (wait_mm_dd 4 05) ;dk-management
  (seed_bed_preparation)
  (sow "Vaarbyg")
  (wait_mm_dd 4 06)
  (sow "SGO_Ryegrass")
  (wait (or (crop_ds_after "Vaarbyg" 2.0)(mm_dd 08 20))) ;dk-management
  (harvest "Vaarbyg" (stub 8 [cm])(stem 0.70)) ;dk-management
  (harvest "SGO_Ryegrass" (stub 8 [cm])(sorg 0.80)(stem 0.80)(leaf 0.80))

  ;;Vårbyg uden rajgræs udlæg. 2003
  (wait_mm_dd 3 05) ;dk-management
  (fertilize ("slagtesvin_gylle" (first_year_utilization 1))(equivalent_weight 75 [kg N/ha])(to -1)) ;dk-management
  (plowing)
  (wait_mm_dd 4 05) ;dk-management
  (seed_bed_preparation)
  (sow "Vaarbyg")
  (wait_mm_dd 4 06)
  (wait (or (crop_ds_after "Vaarbyg" 2.0)(mm_dd 08 20))) ;dk-management
  (harvest "Vaarbyg" (stub 8 [cm])(stem 0.70));dk-management
)
(defaction spring_u_fangafg activity
  P_crop2      ;5 maj 2001
  ;;Vårbyg uden rajgræs udlæg. 2002
  (wait_mm_dd 3 05);dk-management
  (fertilize ("slagtesvin_gylle" (first_year_utilization 1)) (equivalent_weight 75 [kg N/ha]) (to -1)) ;dk-management
  (plowing)
  (wait_mm_dd 4 05) ;dk-management
  (seed_bed_preparation)
  (sow "Vaarbyg")
  (wait_mm_dd 4 06)
  (wait (or (crop_ds_after "Vaarbyg" 2.0)(mm_dd 08 20)));dk-management
  (harvest "Vaarbyg" (stub 8 [cm])(stem 0.70));dk-management

  ;;Vårbyg uden rajgræs udlæg. 2003
  (wait_mm_dd 3 05);dk-management
  (fertilize ("slagtesvin_gylle" (first_year_utilization 1)) (equivalent_weight 75 [kg N/ha]) (to -1)) ;dk-management
  (plowing)
  (wait_mm_dd 4 05);dk-management
  (seed_bed_preparation)
  (sow "Vaarbyg")
  (wait_mm_dd 4 06)
  (wait (or (crop_ds_after "Vaarbyg" 2.0)(mm_dd 08 20)));dk-management
  (harvest "Vaarbyg" (stub 8 [cm])(stem 0.70));dk-management
)
;-----
; autumn ploughing
(defaction autumn_m_fangafg activity

```

```

P_crop2 ;5 maj 2001
;Vårbyg uden rajgræs udlæg. 2002
(wait_mm_dd 10 15);dk-management
(plowing)
(wait_mm_dd 10 16);dk-management
(seed_bed_preparation)
(sow "Vinterhvede")
(wait_mm_dd 10 17)
(sow "SGO_Ryegrass")
(wait (or (crop_ds_after "Vinterhvede" 2.0)(mm_dd 08 20))) ;dk-management
(harvest "Vinterhvede" (stub 8 [cm])(stem 0.70)) ;dk-management
(harvest "SGO_Ryegrass" (stub 8 [cm])(sorg 0.80)(stem 0.80)(leaf 0.80))

;Vårbyg uden rajgræs udlæg. 2003
(wait_mm_dd 3 05);dk-management
(fertilize ("slagtesvin_gylle" (first_year_utilization 1))(equivalent_weight 75 [kg N/ha])(to -1)) ;dk-management
(plowing)
(wait_mm_dd 4 05) ;dk-management
(seed_bed_preparation)
(sow "Vaarbyg")
(wait_mm_dd 4 06)
(wait (or (crop_ds_after "Vaarbyg" 2.0)(mm_dd 08 20))) ;dk-management
(harvest "Vaarbyg" (stub 8 [cm])(stem 0.70)) ;dk-management
)

(defaction autumn_u_fangafg activity
P_crop2 ;5 maj 2002
;Vårbyg uden rajgræs udlæg. 2002
(wait_mm_dd 10 15) ;dk-management
(plowing)
(wait_mm_dd 10 16) ;dk-management
(seed_bed_preparation)
(sow "Vinterhvede")
(wait (or (crop_ds_after "Vinterhvede" 2.0)(mm_dd 08 20)));dk-management
(harvest "Vinterhvede" (stub 8 [cm])(stem 0.70));dk-management

;Vårbyg uden rajgræs udlæg. 2003
(wait_mm_dd 3 05);dk-management
(fertilize ("slagtesvin_gylle" (first_year_utilization 1)) (equivalent_weight 75 [kg N/ha])(to -1)) ;dk-management
(plowing)
(wait_mm_dd 4 05);dk-management
(seed_bed_preparation)
(sow "Vaarbyg")
(wait_mm_dd 4 06)
(wait (or (crop_ds_after "Vaarbyg" 2.0)(mm_dd 08 20)));dk-management
(harvest "Vaarbyg" (stub 8 [cm])(stem 0.70));dk-management
)

;-----
; managements

(defaction nine_year_spring_m_fangafg activity
opvarmning
Nine_year_grasing
spring_m_fangafg
)
(defaction nine_year_spring_u_fangafg activity
opvarmning
Nine_year_grasing
spring_u_fangafg
)
(defaction five_year_spring_m_fangafg activity
opvarmning
five_year_grasing
)

```

```

    spring_m_fangafg
)
(defaction five_year_spring_u_fangafg activity
  opvarmning
  five_year_grasing
  spring_u_fangafg
)
(defaction two_year_spring_m_fangafg activity
  opvarmning
  two_year_grasing
  spring_m_fangafg
)
(defaction two_year_spring_u_fangafg activity
  opvarmning
  two_year_grasing
  spring_u_fangafg
)
)
(defaction nine_year_autumn_m_fangafg activity
  opvarmning
  Nine_year_grasing
  autumn_m_fangafg
)
(defaction nine_year_autumn_u_fangafg activity
  opvarmning
  Nine_year_grasing
  autumn_u_fangafg
)
)
(defaction five_year_autumn_m_fangafg activity
  opvarmning
  five_year_grasing
  autumn_m_fangafg
)
)
(defaction five_year_autumn_u_fangafg activity
  opvarmning
  five_year_grasing
  autumn_u_fangafg
)
)
(defaction two_year_autumn_m_fangafg activity
  opvarmning
  two_year_grasing
  autumn_m_fangafg
)
)
(defaction two_year_autumn_u_fangafg activity
  opvarmning
  two_year_grasing
  autumn_u_fangafg
)
)
)

```